

# RADIO-CRAFT

HUGO GERNSBACK, *Editor*



**TELEVISION-SET TESTING**  
See Page 6

★  
**Still Time!**  
**\$4,000<sup>00</sup>**  
**PUBLIC ADDRESS CONTEST**  
 ★

*Details — Page 21*



**TELEvised 8 MILES**

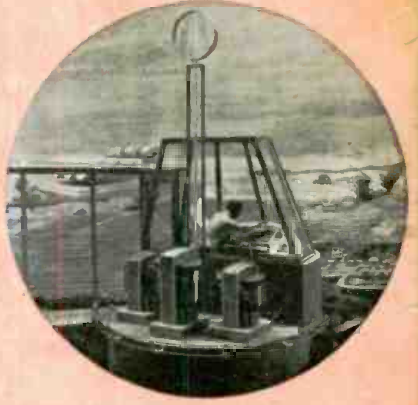

**RADIO FARMER**

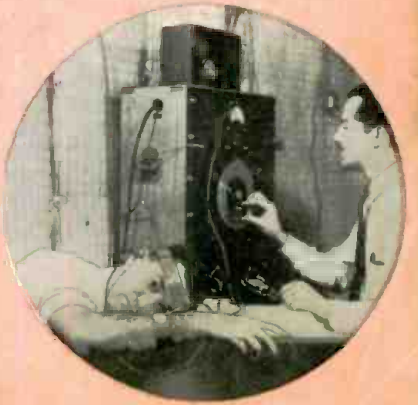

**HUMAN EARPHONE!**

**JULY** RADIO'S GREATEST MAGAZINE  
**25c** HOME-MADE FREQUENCY WOBBLER • SERVICING-TYPE I.F. TUNER  
 IN U. S. AND CANADA P.A.-PHONO-RADIO BATTERY-PORTABLE • ELECTRO-ORCHESTRA



**ANNOUNCING THE NEW**

**CORNELL-DUBILIER**  
*Capacitor*  
**ANALYZER,**  
**BRIDGE AND**  
**DECADE BOXES**



**DESIGNED AND BUILT BY THE**  
**WORLD'S OLDEST AND LARGEST**  
**MANUFACTURER OF CAPACITORS**

**CORNELL-DUBILIER** announces a new line of capacitor test equipment—precision built—laboratory tested and designed with the experience gained in filling the capacitor requirements of engineers and servicemen for the past twenty-nine years. YOU can NOW equip yourself for the greater profits in radio and television with these new C-D testers, economically priced and backed by the C-D guarantee.

**FOR LIMITED TIME ONLY!!** This offer expires Aug. 1, 1939. The convenient coupon below is worth \$1.00! Present it to your local C-D authorized jobber and he will allow you \$1.00 toward the purchase price of any single instrument. You really can't afford to pass up this opportunity.



If this coupon is sent to the factory it will be returned to you with the address of your nearest C-D jobber.

**CORNELL-DUBILIER ELECTRIC CORPORATION, RC7**  
**SOUTH PLAINFIELD, NEW JERSEY**

Please rush to me the following catalog material.

Catalog No. 167A on Capacitor Instruments.  
 Catalog No. 165A on complete line of C-D capacitors.  
 Catalog No. 166A on Quietone Interference Filters.  
 Place me on your mailing list for Free C-D House Organ.  
 Direct me to your nearest authorized distributor.

Name \_\_\_\_\_  
 Address \_\_\_\_\_ State \_\_\_\_\_  
 City \_\_\_\_\_

**CAPACITOR ANALYZER**

The Cornell-Dubilier Capacitor Analyzer will quickly and accurately measure all important characteristics of all types of capacitors. The Analyzer consists of a Wien Bridge connected to a single stage of amplification, operating the "visual eye" detector. A built-in power supply provides 450 volts, D.C. for leakage and insulation resistance measurements.

A 12A7 tube is used as rectifier and amplifier.

**CAPACITOR BRIDGE**

The C-D Midget Capacitor Bridge will quickly and accurately measure all types of capacitors between .0001 and 50 mfd. It employs Wien Bridge circuit for all measurements. Balance condition of bridge is indicated by dual type visual eye detector. This instrument operates from any 110 volt 60 cycle power line. It contains a 12A7 tube as rectifier and amplifier and a 6AF6-G for bridge de-

**CAPACITOR DECADE BOXES**

Cornell-Dubilier Capacitor Decade boxes are ideally suited for experimental circuits, filter design, bridge measurements and a variety of industrial applications. Capacity range between .0001 and 11.1 mfd. is available in three decade boxes. Capacitor decades can be used individually or in group combination. Decades can be used continuously in circuits where voltages do not exceed 220 volts A.C. or 600 volts D.C.

**EXCLUSIVE C-D FEATURES**

while a 6E5 is used for bridge detector and leakage indicator. The C-D Capacitor Analyzer is the only instrument that provides a complete test for all types of capacitors, with amplifier for sensitivity, easy reading linear scales, push-button switches for simplicity of operation, and adjustable DC voltage supply. The Analyzer is supplied in attractive walnut cabinet with removable hinged cover. Analyzer Model BF50 less tubes. List \$41.50

**Net \$24.90**

The C-D Capacitor Bridge is complete, requires no head-phones or other accessories, is supplied in attractive bakelite case, 3 1/8" x 5" x 3" with detachable test leads and instruction booklet. Model BN Capacitor Bridge, complete, less tubes. List \$16.50

**Net \$9.90**

The C-D Capacitor Bridge is the most compact and useful instrument of its type, ever offered the radio industry.

Decades supplied with completely insulated bakelite binding post terminals, and are encased in compact, attractive bakelite cases, 3 1/8" x 5" x 3". Net—nothing else to buy—Model CDA-5 .011 mfd. in .0001 mfd. steps ...

List \$9.00 **Net \$5.40**

Model CDB-5 1.1 mfd. in .01 mfd. steps ...

List \$9.00 **Net \$5.40**

Model CDC-5 11.1 mfd. in 1. mfd. steps ...

List \$16.00 **Net \$9.60**

**VISIT C-D BOOTH (#921 FARADAY AVE.) AT NATIONAL RADIO PARTS TRADE SHOW AT HOTEL STEVENS, CHICAGO**

**RUSH THIS**  
**COUPON! IT'S**  
**WORTH \$1**

**CORNELL-DUBILIER**  
**ELECTRIC CORPORATION**  
 1014 Hamilton Boulevard, South Plainfield, New Jersey



**Men NOW in Radio  
who Don't Think  
they know it All  
Read This**

You don't want to see younger, better-trained men push ahead of you I know. You don't want Radio's new technical developments to baffle you either, I am sure. You want to get ready to "cash in" on Television, too. I have helped many already in Radio to get ahead, to win promotions, to make more money. Read my message below.

J. E. SMITH, President  
NATIONAL RADIO INSTITUTE  
Established 25 years

He has directed the training of more men for Radio than anyone else—has helped men already in Radio to get ahead, and men not in Radio to get into Radio and win success.



**If You're NOT  
Working in Radio Now  
Read This**

Do you want to make more money? Do you want to cash in on your present interest in Radio and Television? Do you want a full-time job with good pay in one of Radio's many fascinating branches? Or do you want to make extra money in your spare time to boost your present income? If you want to do these things—you owe it to yourself to find out how I have trained hundreds of men for jobs in Radio. Read the facts below—and MAIL THE COUPON TODAY.

# Make Me Prove I Can Train You at Home for RADIO and TELEVISION

Clip the Coupon and mail it now. If you're now in Radio, I will show you that my Course gives the training you need to get ahead, to win promotions, to make more money. If you're NOT in Radio, I will show you how I can train you at home in your spare time to be a Radio Expert—even if you've never had electrical or Radio experience or training.

**MANY EXPERT RADIO MEN MAKE  
\$30, \$50, \$75 A WEEK**

Radio broadcasting stations employ engineers, operators, station managers and pay well for trained men. Fixing Radio sets in spare time pays many \$200 to \$500 a year—full time jobs with Radio jobbers, manufacturers and dealers pay as much as \$30, \$50, \$75 a week. Many Expert Radio men open full or part time Radio sales and repair businesses. Radio manufacturers employ many qualified men at good pay. Automobile, police, aviation, commercial Radio, loudspeaker systems are newer fields offering good opportunities now and for the future. Television promises to open

many good jobs soon. Men I trained hold good jobs in all branches of Radio.

Charles F. Helmuth, 419 N. Mass. Ave., Atlantic City, N. J. writes: "I started Radio in the Marines. Later I took the N.R.I. Course. Now I am my own boss, and get jobs over others who were sure they had them. I owe plenty to N.R.I. Training." James E. Ryan, 1535 Slade St., Fall River, Mass. writes: "I was working in a garage when I enrolled with N.R.I. I am now Radio service manager for the M— Furniture Co. for their four stores."

**MANY MAKE \$5, \$10, \$15 A WEEK EXTRA  
IN SPARE TIME WHILE LEARNING**

The day you enroll I start sending Extra Money Job Sheets; show you how to do Radio repair jobs. Throughout your training I send plans and directions that made good spare time money—\$200 to \$500—for hundreds, while learning. I send you special Radio equipment to conduct experiments and build circuits. This 50-50 method of training makes learning at home interesting, fascinating, practical.

**I ALSO GIVE YOU THIS PROFESSIONAL  
SERVICING INSTRUMENT**



Every Radio servicing expert needs an instrument like this—an All-Wave, All-Purpose, Set Servicing Instrument. It contains everything necessary to measure A.C. and D.C. voltages and current; to test tubes; resistance; adjust and align any set, old or new. It satisfies your needs for professional servicing after you graduate—can help you make extra money fixing sets while training.

**SAMPLE LESSON AND 64-PAGE BOOK FREE**

Whether or not you're working in Radio—mail the Coupon for my Sample Lesson. In addition, I'll send you my big 64-page book, "Rich Rewards in Radio." BOTH are free to anyone over 18 years old. My Book points out Radio's spare time and full time opportunities and those coming in Television; tells about my training in Radio and Television; shows you letters from men I have trained, telling what they are doing and earning; shows my Money Back Agreement. MAIL THE COUPON NOW in an envelope, or paste it on a penny postcard.

J. E. SMITH, President  
National Radio Institute Dept. 9GX, Washington, D. C.

**SAMPLE LESSON FREE**

I want to prove that my Training gives practical, money-making information. Is easy to understand—is what you need to master Radio. My sample lesson text, "Radio Receiver Troubles—Their Cause and Remedy" covers a long list of Radio receiver troubles in A.C., D.C., battery, universal, auto, T. R. F., superheterodyne, all-wave, and other types of sets. And a cross reference system gives you the probable cause and a quick way to locate and remedy these set troubles. A special section is devoted to receiver checkup, alignment, balancing, neutralizing and testing. Get this lesson FREE. No obligation. Just mail coupon.

**GOOD FOR BOTH 64 PAGE BOOK FREE  
SAMPLE LESSON FREE**

J. E. Smith, President, National Radio Institute  
Dept. 9GX, Washington, D. C.

Without obligation, please send me a Sample Lesson and your Free Book which points out full time and spare time Radio opportunities and shows how I can train for them at home in my spare time. (Please write plainly).

(Please Check)

I AM doing Radio work.  I am NOT doing Radio work.

Name ..... Age .....

Address .....

City ..... State ..... 14X1

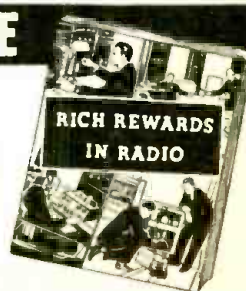

Please Say That You Saw It in RADIO-CRAFT

# RADIO-CRAFT

HUGO GERNSBACK, *Editor-in-Chief*

N. H. LESSEM  
*Associate Editor*

THOS. D. PENTZ  
*Art Director*

ROBERT EICHBERG  
*Trade Digest Editor*

R. D. WASHBURNE, *Managing Editor*

## Contents JULY, 1939 Issue

VOLUME XI -- NUMBER 1

Editorial: 10 Years of <i>Radio-Craft</i> —10 Years of Radio Progress ..... Hugo Gernsback	5
The Radio Month in Review.....	6
How to Make and Use a Frequency Wobbler.....Charles Sicuranza	8
How to Make an "Ideal," All-Purpose Portable—Combines Radio— Phono—Hearing Aid—P.A. System—"Wireless" Phono .....R. D. Washburne and G. E. Archenbronn	10
Tuning with a Rheostat!.....Prof. G. Leithäuser and H. Boucke	13
Announcing!—The Electro-Orchestra.....Benjamin F. Miessner	14
A New Secondary Emission Tube.....	15
How to Design an Inexpensive All-Push-Pull Direct-Coupled 10-Watt Amplifier.....A. C. Shaney	16
New Tube Testers for Checking the High-Voltage-Filament Tubes .....Samuel C. Milbourne	19
Latest Circuit Features in Modern Public-Address Amplifiers—Part I .....L. M. Feiler and M. N. Beitman	20
\$4,000 Public Address Contest [3rd Month].....	21
Servicing "Coin-Operated" Phonographs—No. 2.....Sanford Miller	22
Radio Service Puzzlers.....	23
Servicing Television Receiver Faults—Part II.....S. West	24
Circuit of Commercial Teleceiver.....	26
An I.F. Tuner for Servicemen.....George A. Wall	27
4-Station Radio System—Plus Talk-Back Feature .....N. H. Lessem and Eli M. Lurie	28
New Circuits in Modern Radio Receivers—No. 22.....F. L. Sprayberry	30
Useful Kinks and Circuits.....	31
<b>RADIO SERVICE DATA SHEETS:</b>	
No. 256—Stewart-Warner "Campus" Models 07-511 to 07-519 (Chassis Model 07-51).....	32
No. 257—Pilot Series H-11 4-Tube Battery Portable.....	33
The Latest Radio Equipment.....	34
Radio Trade Digest.....	35
Book Reviews.....	3

### In the NEXT ISSUE

Television Test Equipment  
How to Make a Modern 6-  
Tube Tuned-Radio-Fre-  
quency Receiver for  
High-Fidelity Reception  
2-Tube Earphone Battery-  
Portable for Beginners  
Uses New Permeability  
Tuner  
Servicing Public-Address  
Systems  
Marine Radio Equipment



#### "FOR THE FIRST TIME . . .

. . . in any radio magazine."

The "B'-Batteryless Drycell Radio Set" is the title of another and most amazing "first" which *Radio-Craft* presents to its readers. A standard 1½-V. door-bell "battery" is the only source of power for the 3-tube midget loudspeaker receiver which the author describes; a plate voltage of 100 V. is developed from this single drycell!

The midget proportions of this efficient broadcast receiver were accomplished by utilizing an existing type of A.C.-D.C. T.R.F. chassis and rewiring it, and by using an entirely new line of small-space drycell tubes announced elsewhere in the same issue.

Be sure to read about this revolutionary development, in . . .

. . . AUGUST RADIO-CRAFT



Published by Radcraft Publications, Inc. Publication office: 29 Worthington Street, Springfield, Mass. Editorial and Advertising Offices: 99 Hudson Street, New York City. Chicago Advertising Office: RADIO-CRAFT, 520 North Michigan Avenue, Chicago, Ill.

RADIO-CRAFT is published monthly, on the first of the month preceding that of date; subscription price is \$2.50 per year in U. S. and Canada. (In foreign countries, \$3.00 a year to cover additional postage.) Entered at the post office at Springfield as second-class matter under the act of March 3, 1879.

#### Foreign Agents:

London—Goringe's American News Agency, 9A Green St., Leicester Square, W. C. 2, England.

Paris—Messageries Dawson, 4 Rue Faubourg, Poissonniere, France.

Melbourne—McGill's Agency, 179 Elizabeth St., Australia.

Dunedin—James Johnston, Ltd., New Zealand.



Text and illustrations of this magazine are copyright and must not be reproduced without permission of the copyright owners.



Copyright 1939 Radcraft Publications, Inc.



## BOOK REVIEWS

**PRINCIPLES AND PRACTICE OF RADIO SERVICING**, by H. J. Hicks (1939). Published by McGraw-Hill Book Co., Inc. Size 6 x 9 ins., cloth cover, 305 pages, 212 illustrations. Price \$3.00.

The radio field, and particularly Servicemen, have long awaited "Principles and Practice of Radio Servicing."

It shows how to install, test, and repair radio receivers, giving not only step-by-step instructions in all the servicing procedures, but also plain treatment of theory of electricity and radio needed for most effective approach to servicing problems. *The reasons for circuits are analyzed.*

Written with a minimum of mathematics and in excellent self-study style for Servicemen who want to improve their skill and all who want to learn this practical field from the ground up. *Radio-Craft's* reviewer rates this book tops—a 4-star for the practical man who wants straight-from-the-shoulder answers to his questions.

**RADIO-CRAFT LIBRARY REDBOOKS**. Published by Kadercraft Publications, Inc. Size 6 x 9 ins., paper covers, 64 pages. Price, 50c.

No. 16—**PRACTICAL RADIO CIRCUITS**, by David Bellaire; (1938), 94 illustrations.

Here is a comprehensive guide, to all types of radio circuits for the Serviceman, constructor and experimenter. Included in the hundred circuits which the author states he has selected for their practical value, are data and diagrams under the following chapter headings: Radio Symbols; Broadcast Receivers; All-Wave Receivers; Short-Wave Sets, Converters, Adapters; Automobile Receivers; Public Address; Power Packs; Simple Low-Powered Transmitters; Test Equipment; Television Receivers; Miscellaneous Apparatus.

No. 18—**POINT-TO-POINT RESISTANCE ANALYSIS FOR SERVICEMEN**, by Bertram M. Freed; (1938), 80 illustrations.

This book describes the theory and application of this modern test procedure to everyday radio service problems. Written by the author who introduced the *Radio-Craft* Operating Notes Department, now widely copied under various names by many radio magazines, this book presents more real "meat" than is contained in most radio books of its size. The table of contents shows the wide scope of this book.

Contents: Value of Resistance Method of Servicing; Basic Principles Involved in Point-to-Point Analysis; Methods and Instruments Employed in Resistance Measurements; Point-to-Point Testing Equipment; Easily Constructed Multi-Range Volt-Ohmmeter; Resistance in Radio Receivers; Typical Point-to-Point Analysis of a Modern Receiver; Point-to-Point Resistance Analysis When Receiver Circuit Diagram and Values Are Unavailable; Combination Voltage and Resistance Point-to-Point Analysis; Actual Service Problems.

No. 19—**PRACTICAL RADIO KINKS AND SHORT-CUTS**, by B. Baker Bryant; (1939), profusely illustrated.

It is the purpose of this book to present some of the most useful "kinks" and short-cuts in a form that will be of interest to everyone. A number of the "kinks" are directly applicable to service work and may be instrumental in reducing the time required to locate an obscure difficulty in some faulty set.

No. 20—**THE CATHODE-RAY OSCILLOSCOPE—THEORY AND PRACTICAL APPLICATIONS**, by Charles Sicuranza; (1938) over 60 illustrations.

In "The Cathode-Ray Oscilloscope—Theory and Practical Applications," author Charles Sicuranza has caught the spirit of the modern use of cathode-ray oscilloscopes, and presents one of the most modern and applicational analyses of C.-R. equipment in servicing so far published.

Chapter headings are as follows: Theory and Function of Cathode-Ray Tubes; Power Supplies and Associated Circuits; Sweep Circuits; Operation of a Typical Unit; Methods of Measurement; Practical Applications of Cathode-Ray Oscilloscopes; Solving Unusual Problems with the Oscilloscope.

No. 21—**BREAKING INTO RADIO SERVICING**, by Robert Eichberg; (1938) over 60 illustrations.

The problem of "Breaking into Radio Servicing" is made easier by the simple instructions and procedure for starting a profitable radio servicing business in the book of this title. In this

book the author, in addition to supplying information on elementary servicing technique, picks up where the average radio beginner's technical knowledge leaves off; in the first 2 chapters he handles the all-important business angle of radio servicing in a style that will help many radio beginners to hurdle the problem of getting into and staying in the field. Chapter headings are as follows: Can You Become a Serviceman?; Expanding Your Business; Radio Receiving Fundamentals; Servicing Data; Advanced Servicing Data.

**THORDARSON TRANSFORMER MANUAL NO. 340** (1939). Published by Thordarson Electric Manufacturing Co. Size 8½ x 11 ins., illustrations and diagrams, 183 pgs. Price, 50c.

This book, prepared by the engineering staff of a well-known transformer manufacturer, answers many of the most common inquiries this manufacturer has received during the last few years. This manual includes Radio Service, Transmitter and Sound Amplifier Guides, a Replacement Transformer Encyclopedia and a Transformer Catalog.

The Service Guide includes circuit diagrams and constructional data on test equipment needed every day; modern, high-fidelity, phono-radio amplifiers; charts, tables and other practical information for the Serviceman.

The Transmitter Guide includes up-to-date transmitter designs including recently-developed circuits for the new tubes. Valuable technical data on speech equipment, drivers, driver ratios and modulators. A wealth of accurate information for the amateur.

The Sound Amplifier Guide includes circuit diagrams, parts lists, constructional data, etc., on high-quality amplifiers with outputs suitable for any P.A. requirement. Preamplifiers, mixers, charts, tables and other information needed by everyone interested in public address or sound reinforcement problems.

**SPRAYBERRY DICTIONARY OF RADIO** (1939). Published by Sprayberry Academy of Radio. Size 5½ x 8 ins., 94 pages. Price, \$2.00.

Although this dictionary has been prepared for students of a well-known academy of radio, students of radio in general will appreciate its accurate definitions. Additional and important sections in the book are entitled: Abbreviations; Various Functions of (3.1416); Conversion Table; Greek Symbols Used in Radio; Radio Drafting Symbols; International and Conventional Radio Code Dot-Dash System; Parallel Resistance Chart; Radio Trouble-Shooting Guide; How to Tell What Resistor to Use; Sound Chart; and, Television and Electronic Terms, with Tables, Charts, etc.

**THE RADIO ANTENNA HANDBOOK**, by the technical staff of RADIO (2nd edition). Published by Radio, Ltd. Size, 6 x 9 ins., stiff paper cover, profusely illustrated, 112 pages. Price, 75c in U.S.; elsewhere, 85c.

In this extensive compilation of antenna data, emphasis is laid upon practical aspects, though theoretical considerations are by no means slighted. Comprehensive in scope, it covers the whole antenna problem for the amateur and others using the high frequencies.

In addition to a pictorial section, plus numerous tables, graphs, diagrams and charts, the book contains the following 11 chapters: Fundamentals; Choosing an Antenna; Feeding the Antenna; Transmission Lines; Harmonic Operation; Coupling to the Transmitter; Directive Properties of Antennas; Directable Arrays; Ultra-High-frequency Antennas; Receiving Antennas; Supporting the Antenna.

**ON THE AIR**, by John J. Floherty. Published by Doubleday, Doran & Company, Inc. Size, 7½ x 10 ins., cloth cover, 99 pages, profusely illustrated. Price \$2.00.

Radio enthusiasts of any age will find this pictorial and non-technical description of radio—and of what goes on behind the scenes—interesting reading.

Countless questions are answered by Mr. Floherty and his camera in this vivid presentation of the story of radio and its amazing 20th Century developments (radio broadcasting, television, radio direction finding, radio beacons, etc.).

Please Say That You Saw It in RADIO-CRAFT

# QUICKER & EASIER WAY TO TRAIN FOR **ELECTRICITY** 12 Weeks Practical WORK IN MY CHICAGO SHOPS

## WANT TO EARN MORE MONEY?



Don't be discouraged if you never had a chance to get much schooling. Don't think for a minute that you have to be a poorly paid, unskilled workman the rest of your life. You don't need a lot of book learning to have trained hands. Many of my most successful graduates never even finished Grammar School.



FIRST—You are told and shown how to do it.



THEN—You do the job yourself.

This same training is open to you—12 weeks of actual shop training in **ELECTRICITY**. Yes, shop training—real shop training. Instead of reading how to do things, you do them—right here in my Chicago Shops. You do real work on real generators, motors and dynamos. You do house wiring and wind armatures. You work in many other branches of electricity. And right now I'm including an extra 4 weeks Radio Course and valuable instruction in Diesel, Electric Refrigeration and Air Conditioning—all at no extra tuition cost.

AN EXTRA **4 WEEKS** COURSE IN RADIO INCLUDED

## I'LL FINANCE YOUR TRAINING

Don't let lack of money stop you! I have a plan that makes it easy for you to get this training, and you don't have to begin paying for the greater part of your tuition until 60 days after your 12 weeks training period is over. And then you have 12 months to complete your payments.

If you need a part-time job to help pay living expenses while you train, my employment department will assist you. After you graduate, this department will also give you lifetime employment service. Mail the coupon and I'll send you my big free book that's filled with interesting facts and shows dozens of pictures of students at work—doing the same things you will do. Fill in and mail the coupon today.

H. C. LEWIS, President

# COYNE

## ELECTRICAL SCHOOL

500 South Paulina St. Chicago Illinois



**HOUSE WIRING** only one of the many branches you "Learn By Doing"



Coyne has first class instructors to teach you the simplest things to start with and they have the equipment to show you these things as you advance. Ben Rickman, S. Car.

### MAIL THIS COUPON NOW

H. C. LEWIS, President  
COYNE ELECTRICAL SCHOOL  
560 S. Paulina St., Dept. B9-78 Chicago, Ill.  
Please send me free your big catalog and full particulars of your "Pay After Graduation Plan"—also other facts including offer of extra 4 weeks Radio Course at no extra tuition cost.

NAME.....

ADDRESS.....

CITY.....STATE.....



# For Better Servicing - - For Bigger Profits - - Use Gernsback Manuals and Books!

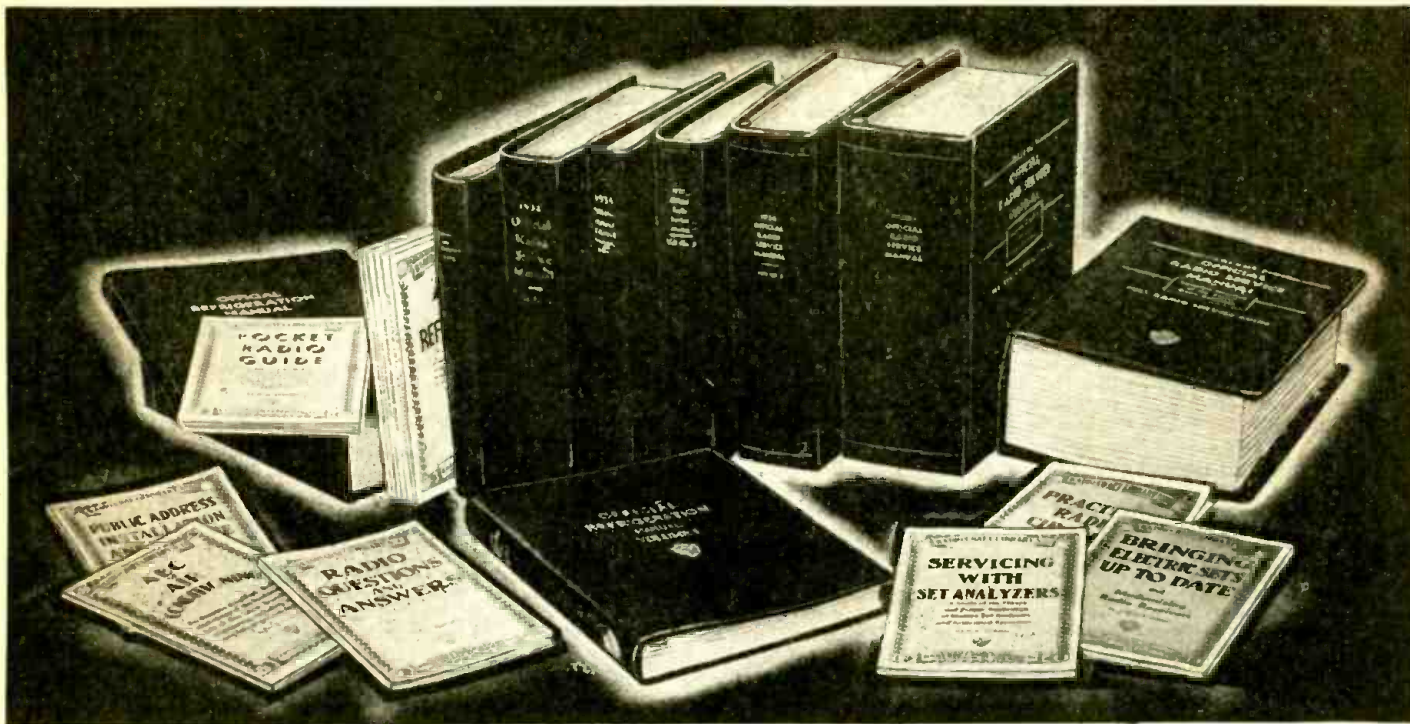

**S**INCE 1931 Servicemen have been buying more GERNSBACK OFFICIAL RADIO SERVICE MANUALS year after year. The authentic material, easily accessible diagrams and complete service data make them invaluable to dealers and radio Servicemen. Without a Gernsback Service Manual at the repair job, there's time and profit lost. Your service kit or laboratory is incomplete without all the GERNSBACK OFFICIAL RADIO SERVICE MANUALS. There are GERNSBACK MANUALS for servicing auto-radios, also refrigeration and air conditioning equipment.

**VOLUME 7 OFFICIAL RADIO SERVICE MANUAL**  
Over 1,800 Pages • Over 3,000 Illustrations • Stiff, Leatherette, Looseleaf Covers • Size 9 x 12 Inches • Net Weight 10½ lbs. **\$10.00**

**1936 OFFICIAL RADIO SERVICE MANUAL**  
Over 1,200 Pages • Over 2,500 Illustrations • Stiff, Leatherette, Looseleaf Covers • Size 9 x 12 Inches • Net Weight 8 lbs. **\$7.00**

**1935 OFFICIAL RADIO SERVICE MANUAL**  
Over 1,000 Pages • Over 3,000 Illustrations • Flexible, Leatherette, Looseleaf Covers • Size 9 x 12 Inches • Net Weight 3¾ lbs. **\$7.00**

**1935 OFFICIAL AUTO-RADIO SERVICE MANUAL**  
Over 240 Pages • Over 500 Illustrations • Flexible, Leatherette, Looseleaf Covers • Size 9 x 12 Inches • Net Weight 1¾ lbs. **\$2.50**

**1934 OFFICIAL RADIO SERVICE MANUAL**  
Over 400 Pages • Over 2,000 Illustrations • Flexible, Leatherette, Looseleaf Covers • Size 9 x 12 Inches • Net Weight 2¼ lbs. **\$3.50**

**1932 OFFICIAL RADIO SERVICE MANUAL**  
Over 1,000 Pages • Over 2,000 Illustrations • Flexible, Leatherette, Looseleaf Covers • Size 9 x 12 Inches • Net Weight 4½ lbs. **\$5.00**

**OFFICIAL REFRIGERATION SERVICE MANUAL (Volume I)**  
Over 450 Pages • Over 1,200 Illustrations • Flexible, Leatherette, Looseleaf Covers • Size 9 x 12 Inches • Net Weight 2½ lbs. **\$5.00**

**OFFICIAL REFRIGERATION SERVICE MANUAL (Volume II)**  
Over 352 Pages • Over 300 Illustrations • Flexible, Leatherette, Looseleaf Covers • Size 9 x 12 Inches • Net Weight 1½ lbs. **\$5.00**

**OFFICIAL AIR CONDITIONING SERVICE MANUAL**  
Over 352 Pages • Over 600 Illustrations • Flexible, Leatherette, Looseleaf Covers • Size 9 x 12 Inches • Net Weight 2¼ lbs. **\$5.00**

To order these famous Manuals, see or write to your jobber or favorite mail order house. If more convenient, mail coupon directly to publishers.

Get into the swing of reading instructive, authoritative books on technical subjects—radio, air conditioning and refrigeration. It's the easiest, quickest and most inexpensive way to improve your knowledge on these topics. In this series, popularly known as the RADIO-CRAFT LIBRARY SERIES, are all the titles necessary to your personal advancement. Only by careful study of these enlightening books, can you gain adequate experience in fields of radio, air conditioning and refrigeration. Each book is uniform. The volumes measure 6 x 9 inches—contain 64 pages, and have stiff, flexible covers. PRICE 50c PER BOOK. All books are sent to you postpaid.

### Here Are The Titles:

- |   |   |
|---|---|
| Book No. 2<br>MODERN VACUUM TUBES               | Book No. 16<br>PRACTICAL RADIO CIRCUITS             |
| Book No. 3<br>THE SUPERHETERODYNE BOOK          | Book No. 17<br>SERVICING WITH SET ANALYZERS         |
| Book No. 6<br>BRINGING ELECTRIC SETS UP-TO-DATE | Book No. 18<br>POINT-TO-POINT RESISTANCE ANALYSIS   |
| Book No. 9<br>AUTOMOBILE RADIO AND SERVICING    | Book No. 19<br>PRACTICAL RADIO KINKS AND SHORT CUTS |
| Book No. 10<br>HOME RECORDING AND ALL ABOUT IT  | Book No. 20<br>THE CATHODE-RAY OSCILLOSCOPE         |
| Book No. 13<br>ABC OF AIR CONDITIONING          | Book No. 21<br>BREAKING INTO RADIO SERVICING        |
| Book No. 14<br>POCKET RADIO GUIDE               | Book No. 22<br>NEW RADIO QUESTIONS AND ANSWERS      |
| Book No. 15<br>ABC OF REFRIGERATION             | Book No. 23<br>PRACTICAL PUBLIC ADDRESS             |

EACH BOOK IN THIS SERIES—50c

**RADCRAFT PUBLICATIONS, Inc., 99 HUDSON ST., NEW YORK, N. Y.**  
Gentlemen: Enclosed find my remittance of \$..... for which send me, POSTPAID, the Manuals or Books indicated below by a cross (x) in the panel.  
( ) Volume 7 @ \$10.00 ( ) 1936 Manual @ \$7.00 ( ) 1935 Manual @ \$7.00  
( ) 1935 Auto-Manual @ \$2.50 ( ) 1934 Manual @ \$3.50 ( ) 1932 Manual @ \$5.00  
( ) Refrigeration Manual (Vol. I) @ \$5.00 ( ) Refrigeration Manual (Vol. II) @ \$5.00  
( ) Air Conditioning Manual @ \$5.00

**RADIO-CRAFT LIBRARY SERIES @ 50c EACH**  
Circle book numbers wanted: 2 3 6 9 10 12 13 14 15 16 17 18 19 20 21 22

Name ..... Address .....  
City ..... State .....

(Send remittance in form of check or money order; register your letter if you send cash or unused U. S. Postage Stamps.)

RC-739

**RADCRAFT PUBLICATIONS, Inc.**  
99 HUDSON STREET NEW YORK, N. Y.

Please Say That You Saw It in RADIO-CRAFT



# RADIO-CRAFT

' ' RADIO'S GREATEST MAGAZINE ' '

## 10 YEARS OF RADIO-CRAFT

10 Years of Radio Progress

By the Editor — HUGO GERNSBACK

**W**ITH this issue *Radio-Craft* completes 10 years of uninterrupted publishing. I take this occasion to voice our heartfelt thanks to the thousands of loyal followers of the magazine, and the large majority of those of our readers who have read the magazine during all these years.

*Radio-Craft* ever since its start has imposed upon itself the Herculean task of portraying from month to month, faithfully, the radio progress of the time; in fact, in very many instances *Radio-Craft* has brought you "exclusives"—often several months ahead—of important radio developments.

*Radio-Craft* has consistently been far in advance with its reporting, over many other magazines, so much so that it is now frequently used as a reference library by our large radio corporations in patent research, and for various industrial and commercial purposes.

Radio has come a long way since 1929 and even radio experts—those who are closest to the picture—often stop to wonder, when they contemplate the tremendous progress of the Art. Several pages set in fine type could be taken up in cataloging radio developments since 1929 but for the purpose of this editorial I will confine myself only to the more outstanding radio inventions and developments which have taken place since the first issue of *Radio-Craft* was published.

\* \* \*

Let us take, for instance, the most obvious—radio tubes. In 1929 we had no screen-grid tubes, no pentodes, no direct-coupled, secondary-emission tubes, no variable- $\mu$  tubes, no metal tubes, no tuning "eye" tubes, no octal, loctal, acorn, beam power, Thyatron, gas-filled relay, or low-drain drycell tubes either. Then, too, we did not have black-and-white cathode-ray tubes; the modern cathode-ray tubes, which finally have made television possible.

In 1929 we had no car radios, no all-wave radio sets, nor the modern midget radio sets. We did not have pushbutton-control radio sets, nor the hotel radio systems in vogue today. The new self-contained portable "A.C.-D.C. and battery" radio sets, built-in antennas, all were still in the distant future. Our radio sets still faded badly because in 1929 we had no automatic volume control whatever, neither did we have automatic frequency control. Our radio sets too were noisy because inter-station noise suppression circuits were still an unknown factor in those days. This condition was still more aggravated because noise-free antenna systems had not as yet been invented. Neither did the radio set of 1929 have radio remote volume and tuning control systems.

Indeed if you take the radio receiver of 1929 vintage and place it alongside our modern radio sets the comparison will be laughable. Of course, we had neither high-fidelity sets, in those days, nor high-fidelity broadcasting. The high-fidelity loudspeaker with its high-fidelity baffles (acoustic labyrinths, etc.) had as yet not appeared. Neither did we have the compensated tone controls nor wave-band selection and push-pull circuits of the many types in common use today. Such modern technical radio set adjuncts as for instance, iron-core radio-frequency coils, swinging choke coils, A.C.-D.C. circuits and equipment, multiple-receiver antenna systems, A.C. elec-

trolytic condensers, all-wave antenna systems, ballast tubes and many others were totally unknown; or at best were only nebulous ideas or, only laboratory experiments.

On the broadcast transmission end, electric recording was an unknown entity. Crystal microphones, ribbon microphones, uni-directional microphones, all were still in the future. Controlled acoustics in studios had hardly been thought of; frequency modulation was known in principle perhaps but could not be successfully applied. On the television end, electronic television was still a theory; as were 3-dimension television and color television.

Simultaneous television sight (video) and sound (audio) transmission first advocated by me editorially in November, 1930, did not come about until recently. It is now being used in all modern television transmitters.

In 1929 the facsimile radio transmitter had not been developed; nor did we have the radio typewriter; nor radio hookups whereby we control machinery and apparatus at a distance by radio.

Public address was still in its merest infancy, we had no super-power P.A. systems, no interoffice communicators, no direct-coupled amplifiers, no crystal loudspeakers, no highly-efficient sound recording, no push-pull and class B circuits and equipment, no commercially-practicable sound-on-steel tape, no home, school and industrial talkies, no mobile public-address systems.

In the airplane we had no inter-communicators and remote-controlled multi-wave radio receivers, no airplane direction finders, and no blind landing and blind flying facilities, no radio altimeters, and no anti-static plane-radio systems.

Finally, we had no electronic music, we had no modern testing apparatus (cathode-ray oscilloscopes, etc.), we had no "wireless" phonographs, no negative-feedback circuits and equipment, and we had no radio "treasure" finders.

Medicine, as yet, was wholly ignorant of radio diathermy which has made tremendous strides during the past decade. The radio knife was still to be invented in 1929. We had no 2-way police radio, the *radiosonde*—balloon radio set for meteorological measurements—was still to come.

The efficient and varied test equipment we have today for servicing was wholly unknown. Precision tube- and set-testing equipment such as pushbutton test units, all-wave oscillators, cathode-ray servicing oscilloscopes and wobblers, multi-range high-sensitivity test meters, simplified bridges, noise meters and many other test devices were not known.

In closing a long and incomplete list I might also mention the following "unknowns" in 1929:

Fire department radio, portable transmitters and receivers, manufactured speech ("Voder"), ultra-shortwave converters, radio sextant, vibrator-type "B"-power supply units and vibrator-type power converters, crystal control of frequencies, photoelectric recording and playback, call systems (Radio Nurse, restaurant order phones, hotel and train paging systems, etc.), church electronic carillons, electronic pianos, organs, etc., electronic hearing aids, coaxial cable (used mainly in television), talking books for the blind, volume expansion, railroad radio, and to conclude, radio insect exterminators.





Visitors to the General Motors Highways and Horizons exhibit at the New York World's Fair view the World of Tomorrow from comfortable moving sound chairs while touring for 15 mins. a vast scale model, of the American countryside, extending for 1/3-mile on several levels of the building! The "futurama" is the largest scale model ever constructed and includes more than 500,000 buildings and houses, over a million trees and 50,000 tiny motor vehicles, of which many thousands are in motion. Some 150 P.M. dynamic loudspeakers set edgewise at ear level deliver a running commentary on the scenery, picking up 150 different portions of a correlated speech as the carry-go-round progresses. The sound-film device which makes this possible is a 20-ton marvel of ingenuity known as the Polyrheter (See June '39 *Radio-Craft*, pgs. 721 and 752, "Radio—at the World's Fairs."), or "Robot Guide," designed by Bell Labs. and ERPI; built by Western Electric Co.



TELEVISION-SET TESTING

An RCA Victor television engineer tests a Kinescope (cathode-ray receiving tube) in the company's laboratories. (This view is also shown, encircled, on cover.) The pattern seen on the tube is the special one developed for this test and shown in more detail on pg. 687 of May *Radio-Craft*.



THE RIDERLESS BIKE!

An "electric eye" is the phantom rider of this bicycle, now clipping off 28 miles an hour in a 365-day sprint at the New York World's Fair. The "electric eye" (2) receives light reflected from a tiny mirror (1) on the bicycle frame. (See pg. 43.)

# THE RADIO MONTH

## SOUND

**"MUSEUM ANIMALS** "wired for sound" was the title of a newspaper item last month. It seems that the American Museum of Natural History (N.Y.) is going to give visitors an opportunity to "hear" the stuffed African lions, Congo jungle birds, etc. Phono records, reproduced from mobile equipment, will be used. These sound effects, including the music of jungle dancers, were made in the Museum's Akeley African Hall.

Last month the American Foundation for the Blind announced publication of the first magazine published in sound instead of in print. It is hoped that the approximately 130,000 blind persons in the U.S. will soon be able to listen to recorded versions of popular magazines, reviews of the new talking books, and general literary notes, all via phono-graph discs.

## SHORT WAVES

**T**HE American Radio Relay League campaign for safety among radio amateurs is credited with having saved the life of a young Pennsylvanian amateur last month who came out second best in a wrestling match with a potential of 3,500 V. When he came to, some time later, he found that his father, also an amateur, had applied artificial respiration in accordance with instructions he had read in *QST*.

## TELEVISION

**T**HE CROSLY CORP. has leased the entire 48th floor of Cincinnati's Carew Tower for construction of tele-

vision studios, vice-President James D. Shouse announced last month. Carew Tower, 574 ft. high, will have an estimated service radius of 25 miles. The transmitter is rated at 1,000 W., and work is progressing rapidly. "Look and listen"—for this new mid-West telly station.

Next time you plan to take your secretary out for the evening, better tell the wife—at least, if you're in London. Latest stunt of the British Broadcasting Corp., last month, was to chase the police cars around town and, with the telemobile unit, televise traffic violators as the Bobbies did their stuff. Isn't it conceivable that a particularly telegenic cop might whistle cars to the curb a trifle too frequently? What next!

If a 1-second "snowstorm" suddenly replaces an image on televiewer screens at the New York World's Fair, don't take it too seriously—it's probably just a 10-million-volt bolt of man-made lightning at Steinmetz Hall, a few hundred feet away.

In a 2-part article, *Fortune* magazine has successfully presented the most modern and complete analysis of its topic so far available. "Television I: A \$13,000,000 'If'" generalizes on the problems involved; "Television II: 'Fade In Camera One!'" goes right to bat on specific subjects—including the pros and cons of present-day systems. The problem of obtaining suitable program material for television broadcasting ("video-casting," *Fortune* calls it) is given detailed attention in Television II.

If you plan to get into television, read the following item which we quote with *Fortune's* permission: "The General Electric Co. has made a tentative projection to 1944. The figures given are these:



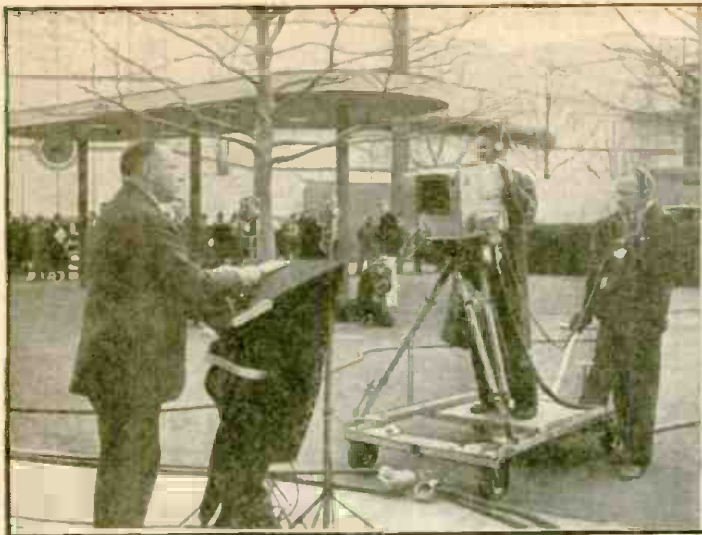

DAVID SARNOFF WAS PHOTOGRAPHED . . . AND TELEVISED, AT THE N. Y. WORLD'S FAIR

It's a downright fib to say "the camera doesn't lie," at least insofar as it concerns catching on a photographic film the same sort of image our eye perceives when viewing the phosphorescent end of a cathode-ray television receiving tube. *Radio-Craft* can attest, from having witnessed by television 8 miles away the dedication program, in connection with the RCA Exhibit Building, at which these photos were taken, that the image photo at top-right (and reproduced on cover) does not convey the same impression of "photo fidelity" which was experienced when the image was viewed directly on any one of 15 receivers. The reasons for this result are given elsewhere in this department.

## IN REVIEW

Year	No. of Sets	Average Price
1940	199,000	\$250
1941	414,000	200
1942	846,000	160
1943	1,371,000	150
1944	1,903,000	140

(A total of 4,760,000 telereceivers and a total list-price value of \$750,000,000.)

It is estimated that these receivers, at the end of 1944, will be served by 512 stations (on the 7 lowest channels) costing, for equipment, about \$54,000,000.

Television II, last month, pointed out that about \$13,000,000 has already been invested in television.

## BREVITEMS

**"PHANTOM PLAYERS,"** an illustrated item in this department in *Radio-Craft* of December, 1938, described how a German radio company has produced a library of over 300 phono recordings, all with missing musical elements that the record purchaser fills-in by solo playing during playback.

Last month King Ross, Jackson Heights, N.Y., was granted a patent for a "subdued-melody phonograph and accompaniment record," in which the

melody is muted to a whisper, and the record purchaser then sings or plays-in the melody.

**Albert J. Rathwell**, North Bay, Ont., last month was granted a patent for a fire-sprinkling control system actuated by an impulse from an electric eye, arranged to detect smoke. This seems to be a better scheme than one which depends upon heat, inasmuch as a smudge fire may smoke for quite a while before developing any considerable amount of heat and breaking into flame.

**Marek Weber**, maestro of the N.B.C. Carnation Contented program, now knows what it feels like to set off a burglar alarm by mistake. While sitting in the studio control room during rehearsal last month, Weber absent-mindedly turned a knob on the engineers' control panel. In 5 seconds the place was jammed with engineers. The gadget was the so-called "SOS button" which sets off alarms in the main control room, the engineering, and the maintenance departments of the Chicago studios.

An old-fashioned corset with metal stays nearly had the El Reno Federal reformatory at Weatherford, Okla., in an uproar last month when a lady visitor actuated the electromagnetic "frisker." "You seem to have metal of some (Continued on page 43)

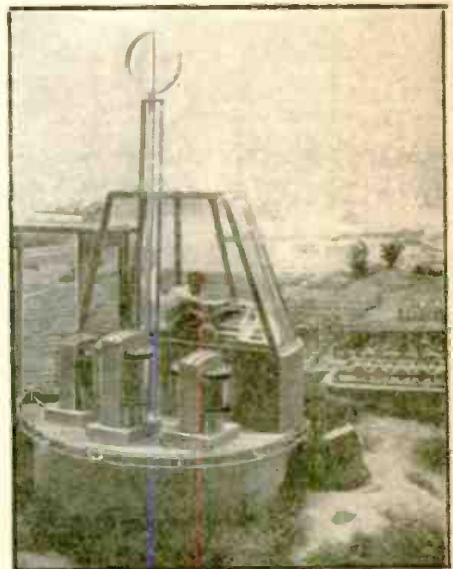

THE RADIO FARMER

Farming by radio (illustrated on cover), an imaginative representation of the Farm of the Future, where radio beams direct every activity from sowing to shipping, is a feature exhibit under the stainless steel dome of the United States Steel Subsidiaries building at the New York World's Fair. From a radio control tower in the center of his farm, a "Buck Rogers" farmer can send his instructions to the machines that sow, cultivate, irrigate, reap, can or freeze, pack, and ship his agricultural products. Portraying "tray agriculture" and intending to illustrate how steel might serve the Farmer of Tomorrow, the diorama will show by animation the "radio farmer" operating his controls, a sprinkler system spraying simulated tomato plants, conveyor belts carrying vegetables to the packing center, and even trees swaying in an artificial breeze.

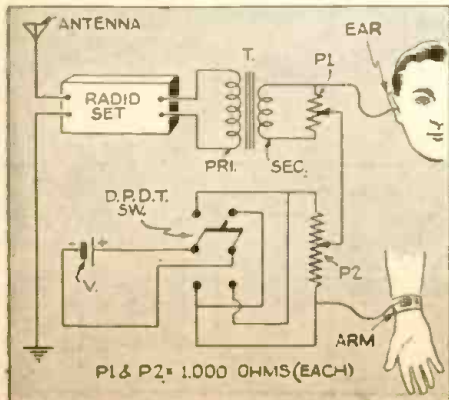

**HUMAN EARPHONE!**  
Last month Dr. S. S. Stevens (Psychological Lab.), and Dr. R. Clark Jones (Research Lab. of Physics), Harvard Univ., showed that radio programs (for instance) can be heard without headphones by feeding the signal to an electrode immersed in a saline solution in the ear (as shown at right and on the cover).

At left, an experimental circuit. Unit T is a tube-to-line transformer. The ear contact is a finned copper wire immersed 1/4-in. into ear solution (1 level teaspoon full of salt to 1 cup of water); arm contact, an aluminum disc, strapped on.





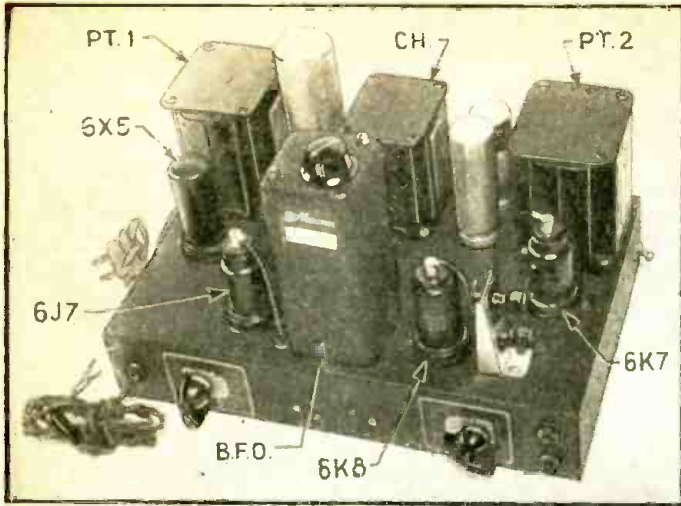

The completed, entirely-electronic frequency wobbler, ready for use. Its band width is adjustable from 0 to 40 kc.

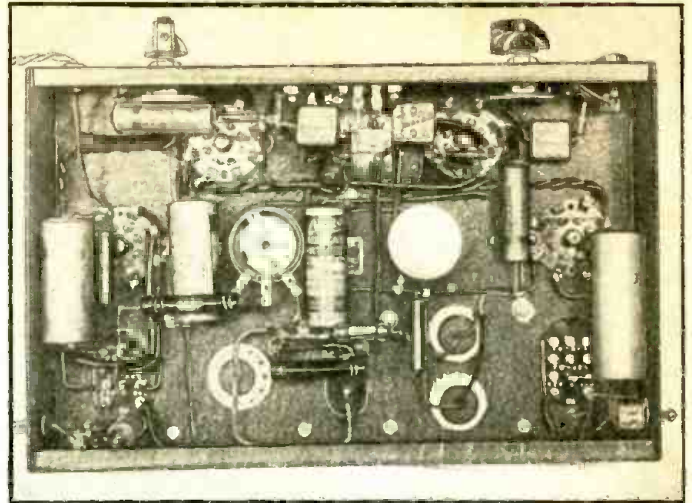

Underchassis view showing the neat arrangement of the various components. The controls are (left) sweep kc. band width and, (right) attenuator.

# HOW TO MAKE *And Use*

## Features

- (1) Fully electronic in action, no motors.
- (2) Adjustable band width, 0 to 40 kc.
- (3) Fully self-contained, for fixed I.F. alignment work.
- (4) Can be used with any commercial or home-built oscilloscope, which has an internal sweep system, such as the 3-in. scope described by the author in past issues of *Radio-Craft* or the 1-in. and 2-in. scope described by H. G. McEntee.
- (5) Can be used with any R.F. oscillator or signal generator to provide a wobbled output at any frequency desired, where the band width generated, being a function of the fixed oscillator, remains constant at any alignment frequency.
- (6) Self-contained "pyramid sweep generator" which makes possible the use of "double trace" alignment for highly accurate work.
- (7) Variable band width control, giving calibrated reading in kc., of I.F. channel response.
- (8) Self-contained synchronizing pulse which is fed into scope, allowing image to be centered and locked during alignment.
- (9) Adjustable output frequency control. Knob setting may be varied to obtain 456, 460, 465, 470 or 480 kc., covering most used intermediate frequencies of modern sets.
- (10) Wobbler output control to prevent overloading of sensitive I.F. channels.

NOTE—Due to the time constants involved, this wobbler can be used only on 60-cycle current of 110 to 120 volts. However, by making some major changes such as changing the power transformers, operation can be effected at 25, 40 or 50 cycles (remembering that each of these 3 frequencies requires different values of capacity for the sweep circuit).

*There has been an insistent demand for a simple frequency-would give worthwhile results. Herewith is a description clamorous clanging of our constituents and supplement*

SINCE no instrument is really useful unless thoroughly understood, we shall try to give a clear explanation of how and why each circuit works, in this 4-tube, fully-electronic, adjustable-band-width frequency wobbler, in the order named. We will not dwell upon the generalities of "why a wobbler?" since the subject has been amply discussed in past issues of *Radio-Craft*. Rather, we will dig right into the story of how to make a modern unit, and then give specific instructions on its use. Refer to the schematic diagram, Fig. 1.

1. Power supply.
2. Fixed-frequency oscillator.
3. Frequency control.
4. Sweep generator.

## POWER SUPPLY . . .

This section consists of 2 identical power transformers, designed for this class of work, that is, small oscillators, preamplifiers, etc.

One transformer supplies the heater and "B" voltage requirements for the whole unit; the other transformer only

supplies 235 volts A.C. to the plate

**CHARLES**

of the sweep-frequency generator tube.

The 6X5 rectifier supplies "B" voltage through a small choke to the bleeder resistor network. The filter condenser values given are necessary for good results. Note that the SYNC. circuit ties in at the cathode of the 6X5, where there is available a 120-cycle sawtooth voltage. More of this later.

## OSCILLATOR . . .

We come now to the oscillator circuit. There is nothing unusual in the oscillator circuit itself. It is the *external connections* to the oscillator circuit that count. For instance note that the grid winding feeding the triode grid (of the 6K8) carries "B" voltage to the frequency control tube plate. Also note that the pentode plate (of the 6K8) feeds into the frequency control tube grid. The net result is that there is a tube in shunt across the grid winding of the oscillator, shown in Fig. 2. Now for the 3rd item in our listing.

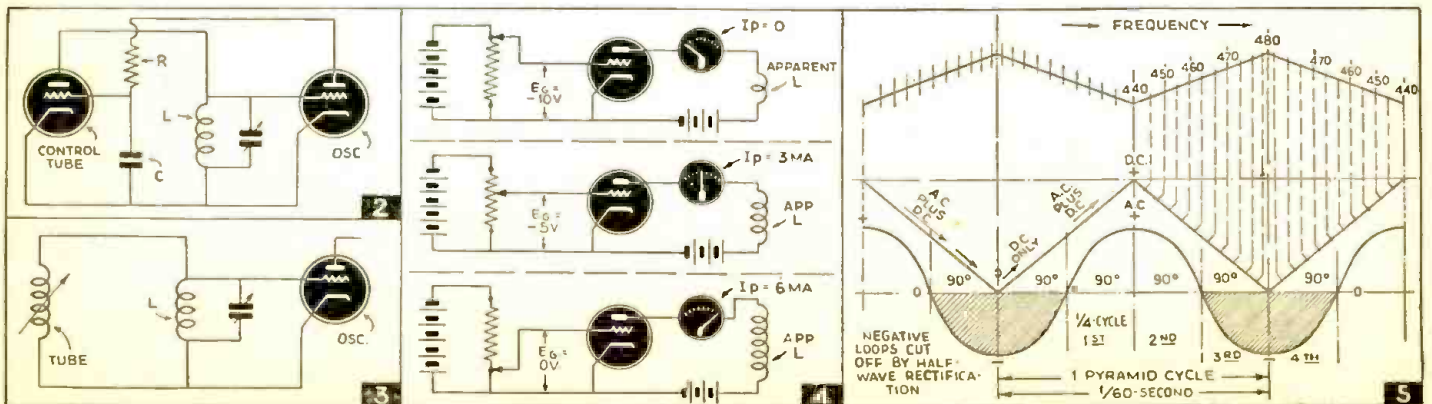

Figs. 2, 3, 4 and 5.



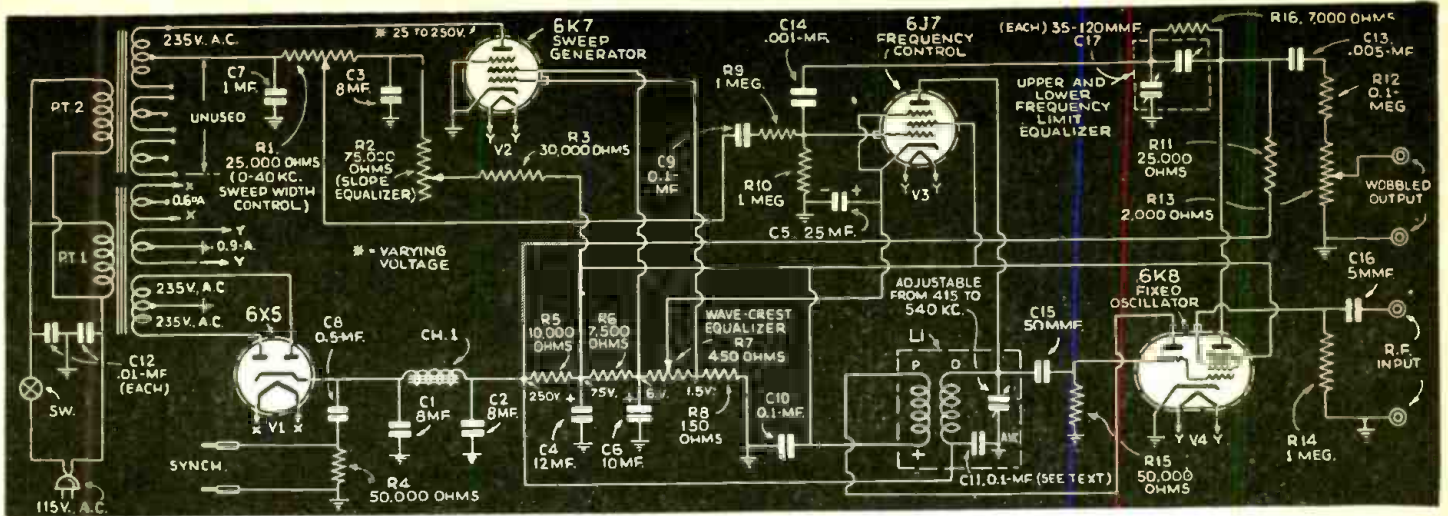

Fig. 1 Complete schematic diagram of the fully-electronic frequency wobbler.

# A FREQUENCY WOBBLER

modulated oscillator which would be easy to make and that of a "fixed frequency" wobbler which should quiet the "Frequency 'Wobblers' for Service Oscillators," Nov. '37.

## SICURANZA FREQUENCY CONTROL . . .

As will be shown, *this tube is made to act as if it were a variable inductance*, connected across the oscillator grid winding, as shown in Fig. 3. How this is done is best explained by remembering that the current flow through an inductance *lags* 90 degrees behind the voltage, while the current through a condenser *leads* 90 degrees ahead of the voltage.

Now refer to Fig. 2 and study the following action very carefully; the oscillator feeds an alternating voltage (through the phase-shifting network, R-C) to the grid of the control tube. This alternating voltage *LAGS* 90 degrees behind the current through C. Now since the *grid voltage* and *plate current* of this tube are in phase, then a 90 degree LAG in GRID VOLTAGE is identical to a 90 degree LAG IN PLATE CURRENT. The distinguishing characteristic of an inductance, electrically speaking, is this very same 90 degree current lag and therefore we have

achieved our purpose; thus, since the lagging current drawn by the control tube flows through the oscillator grid winding L, that is from plate to cathode of the control tube, then the apparent inductance of the tube is in parallel with the actual inductance of L.

The amount of lagging current drawn by the control tube determines how large the apparent inductance will be and this can be controlled by varying the grid bias of the control tube. Thus for each value of plate current there is a corresponding amount of apparent inductance. See Fig. 4.

## SWEEP GENERATOR . . .

It is not enough (for our purpose) to just vary the grid bias of the control tube. The bias voltage required for "double trace" performance must vary from a low value to a high value and back to the low value, in a linear manner, at a definite time rate. This is called a *pyramid linear sweep* and is shown in Fig. 5.

Trace through the sweep generator circuit on Fig. 1, and you will see that the 6K7 sweep tube passes direct current all the time and also passes rectified current from each positive A.C. loop, half of the time. Both the alternating and the direct current must flow through the high-inductance secondary winding of the power transformer, so that on each positive A.C. loop (see Fig. 5) the A.C. voltage adds with the D.C., reaching a peak value at the top of the ascending (1st) quarter-cycle. On the descending (2nd) quarter-cycle the A.C. and D.C. voltage together race down to the zero value 90 degrees ahead of the combined alternating and direct currents, which

(Continued on page 46)

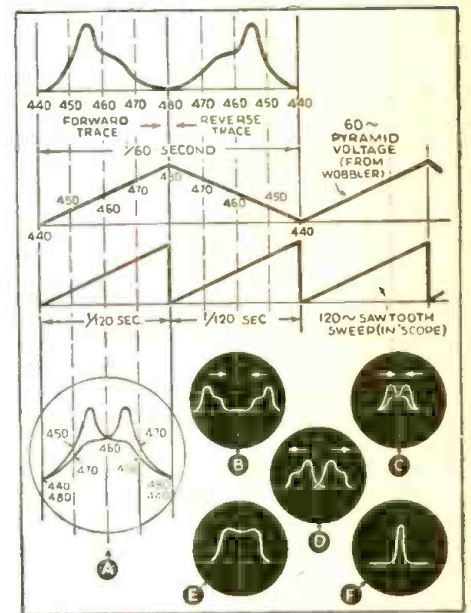
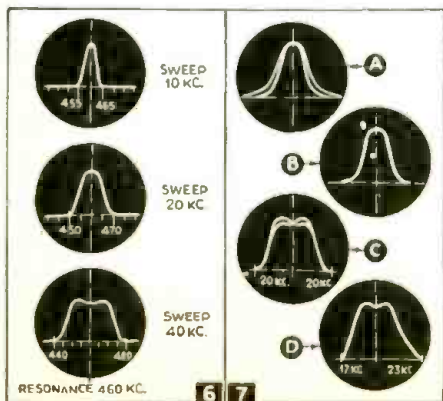

Fig. 8



Figs. 6 and 7.

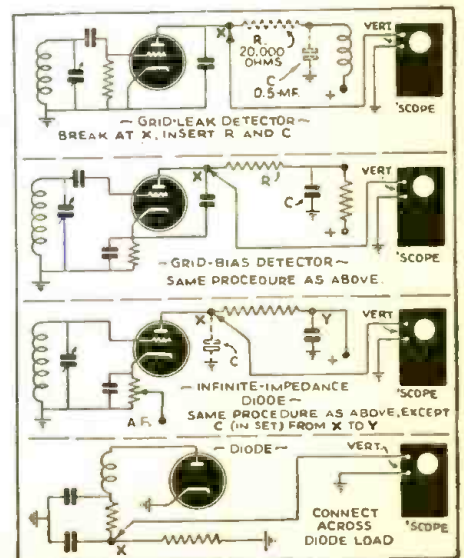

Fig. 9



# HOW TO MAKE AN "IDEAL"

## *Combines Radio--Phono--Hearing Aid*

*Ah!, June!, when a radio man's fancy lightly turns to thoughts of . . . portable more than a spring time idyl, it is in fact a year-'round instrument-of-many-uses.*

R. D. WASHBURNE and



A pretty girl, music anywhere by means of this battery-powered portable electric phonograph (or, you may have a radio program, if you prefer!)—well, what are we waiting for, on with the dance!

**E**VERYBODY is "swinging" these days—but stop jitter-bugging and alley-cattin' around long enough to look over the newest and most unusual entertainment ensemble ever designed. You name it—we can't! It's a radio, a phonograph, a "wireless" phonograph, a P.A. system, and a hearing device, plus space for about 20 records, all tucked compactly into a smart piece of airplane luggage, ready to put a new zip and thrill into your summer play-time hours.

Whoever you are, after you've read this article you'll want to pay a visit to your favorite radio man and start him building this combination for you—and, if you are the radio man, you'll be eager to build one for yourself with the profits of your handiwork. (The writers wonder how long it will take the radio industry to catch up with this new and novel Ideal 6-Tube All-Purpose Battery-Portable?)

As shown in the illustration, the combination is built within a piece of luggage 18 x 14 x 8½ ins. deep. There is no aerial or ground wire necessary; the antenna is built into the cover. No preparation whatsoever—just open the cover, turn on the set, and make the slight adjustment for the type of reception you want.

### USES

Easy to carry, it requires little space in an automobile or boat. Inside, you'll find everything you want in the nature of musical entertainment for a moonlight picnic on the beach, for a weekend at the lakes, and for all the varied activities of an entire summer vacation.

And, after you've taken it with you fishing, canoeing, camping, picnicking; after you've whiled away idle, vacation hours in a trailer, on a boat deck, or on a cottage veranda, bring it home and use the wireless phonograph to recapture summer memories by playing your favorite records through the larger home radio without even attaching a wire to same. This operation utilizes only 1 tube, and the drain on the battery is negligible.

Should grandma be hard of hearing—we've thought of her, too—a pair of headphones and a microphone may be attached as a hearing aid. And, when a party reaches the zero hour and it's a question of "what can we do now?", rig up a mock broadcast from the closet and fool and entertain your guests. If it's "after-hours" in your apartment or hotel, and "Quiet is requested for the

comfort of all guests," thumb your nose at the rules, attach enough headphones for the family, and enjoy your favorite program or records, no matter what time it may be.

To make the combination doubly valuable, it has a more far-reaching use than just as a "having-fun-helper." Battery-operated, it makes an ideal unit for any community group in a locality not electrified. A rural school would find it invaluable for both entertainment and musical appreciation classes—a country church or Farm Bureau would discover it a welcome addition to their social functions. The speaker and baffle may be removed for a distance up to 25 feet, simply by 2 thumb-screws, making a splendid and effective Public Address system for both indoor and outdoor picnics, dinners and group meetings.

That gives you a brief idea of why it's a "handy little gadget to have around the house." It has about all that any portable or phonograph on the market has, plus a number of added features. Its sensitivity of reception gives more than average professional

performance—its size and compactness make it convenient and practical to transport—and its smart appearance makes it an ensemble you'll be proud to carry anywhere. Open, it offers any type of music you may want—closed, it might be a weekend bag, trim, compact, weather-proof. At home or travel-

ing, enhance your pleasure with your own, specially-built "IDEAL" ALL-PURPOSE PORTABLE. It will do anything except perhaps get you to work on time—and, if you add to it a circuit-closing clock, it may even help to do that!

### THE CASE

The case is purchased as a complete mechanical portable phonograph. The soundboard in the cover comes with the necessary openings required to mount the P.M. speaker and its baffle. Carefully remove the side supports of the soundboard, which releases the same. It is necessary to remove the tin backing which forms the air chamber. Remove the 3 screws fastening the mechanical tone arm. Cover this opening with a metal plate 2 x 1½ ins. A hole should be drilled ⅝-in. from the front edge and at the center-line of the ends;





# ALL-PURPOSE PORTABLE

## -- P.A. System -- "Wireless" Phono

radio sets! And so we present . . . the Ideal 6-Tube All-Purpose Battery Portable; Man or maiden, child or grown-up, this ultra-modern set suits anyone, anywhere.

G. E. ARCHENBRONN

and 5/16-in. mounting holes should be drilled in each corner 1/4-in. from edges.

Replace the two soundboard supports directly on to the soundboard only with 1/2-in. wood-screws. Hinge the soundboard to the case at respective intervals to facilitate removal of the soundboard to extend the speaker for public address use. Next fasten the spring clamp to the case cover and sounding board.

Cut a baffle from ply-wood 13 1/2 x 10 1/2 ins. and mark off center for speaker opening. Cut out two 2 x 2 in. squares, one on each side of speaker 5 1/4 ins. from top and 2 1/4 ins. from side, the latter for back-wave.

Next, remove the partitions from the record compartment but leave the partition between the motor and the record compartment. Chisel a square (for the "A" supply and volume control cable) 3 ins. from the top-rear end of the partition between the motor and the record compartment.

Remove the right-hand needle cup from the motorboard and drill a hole, using the needle cup screw hole as a center, to take the microphone-phonograph switch. On center line of the motorboard and 3/8-in. in from the back

### Applications

- (1.) Portable radio set for camping trips, etc.
- (2.) Direction finder for small boats, and for locating sources of interference (in service work, when customer complains of "static"), and so on.
- (3.) Public address unit for use in store windows, etc.
- (4.) Hearing aid.
- (5.) "Quiet" radio set (headphone reception) for sick-rooms, hotel rooms, for children's educational and entertainment programs (so as not to tie-up the regular home set tuned to adult programs), etc.
- (6.) Amplifier for electronic music set-ups, using contact mike.
- (7.) "Wireless" phonograph for adding phono facilities to any radio set without internal connections being necessary.
- (8.) Call system, for paging, etc., with the unit's removable loudspeaker placed at the end of its 25-ft. cable.
- (9.) Detective phone (using mike for pick-up and phones for listening).
- (10.) Portable phonograph for use where radio set will not operate, or when radio programs or program hours do not suit requirements.
- (11.) "Wireless" public address unit for mock broadcasts (using standard home radio set), and other entertainment ideas of a similar nature.
- (12.) Sound reinforcement unit, as in a small orchestra or at a lecture.
- (13.) "Wireless" detective phone for sending sounds a short distance through walls to a nearby set, and wherever such a short-distance phone is wanted.
- (14.) Emergency radio set for use when regular electric set becomes inoperative due to storm, flood, etc.
- (15.) May be used to complete a 2-way communication system in conjunction with a home radio set provided with tip-jacks for "home broadcasting" and home recording.
- (16.) Placed in child's room, it may be used as a "radio nurse" to warn when baby is ready for a feeding, etc. The loudspeaker may be extended the required distance, for this service, or unit may be operated as a "wireless" P.A. device.
- (17.) As a service oscillator for emergency work where a regular calibrated, modulated oscillator, working in the broadcast band for set-testing, is not available or is inoperative.

cover side, drill a 3/8-in. hole to accommodate the microphone jack. The tuning control shaft hole (3/8-in.) is located 2 ins. from the record compartment cover by 1 3/4 ins. from the front or lock end. The change-over switch hole

(3/8-in.) is located on center line to the sides and 1 5/16 ins. from the front edge. The volume control mounting hole is located 2 ins. from the crank side and 1 3/4 ins. from the front end.

(Continued on following page)

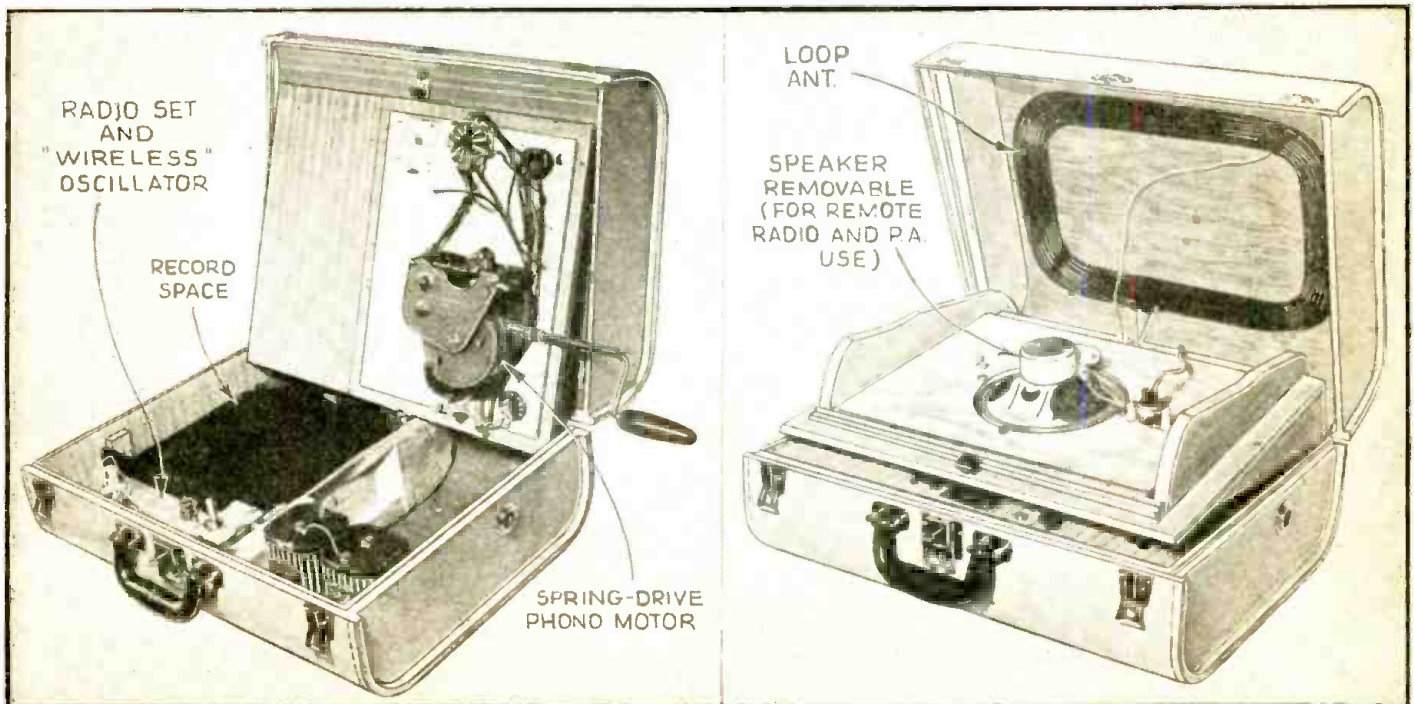

Left, showing the manner in which the spring-driven phono motor (which comes with the case), and the removable loudspeaker, are mounted. Right, general arrangement of the loop antenna is shown. This type of antenna, it will be recalled, is particularly useful for direction-finding work (locating interference, on a boat for taking bearings during a fog, etc.). The completed unit, tested by *Radio-Craft*, was found to do all that was claimed for it.



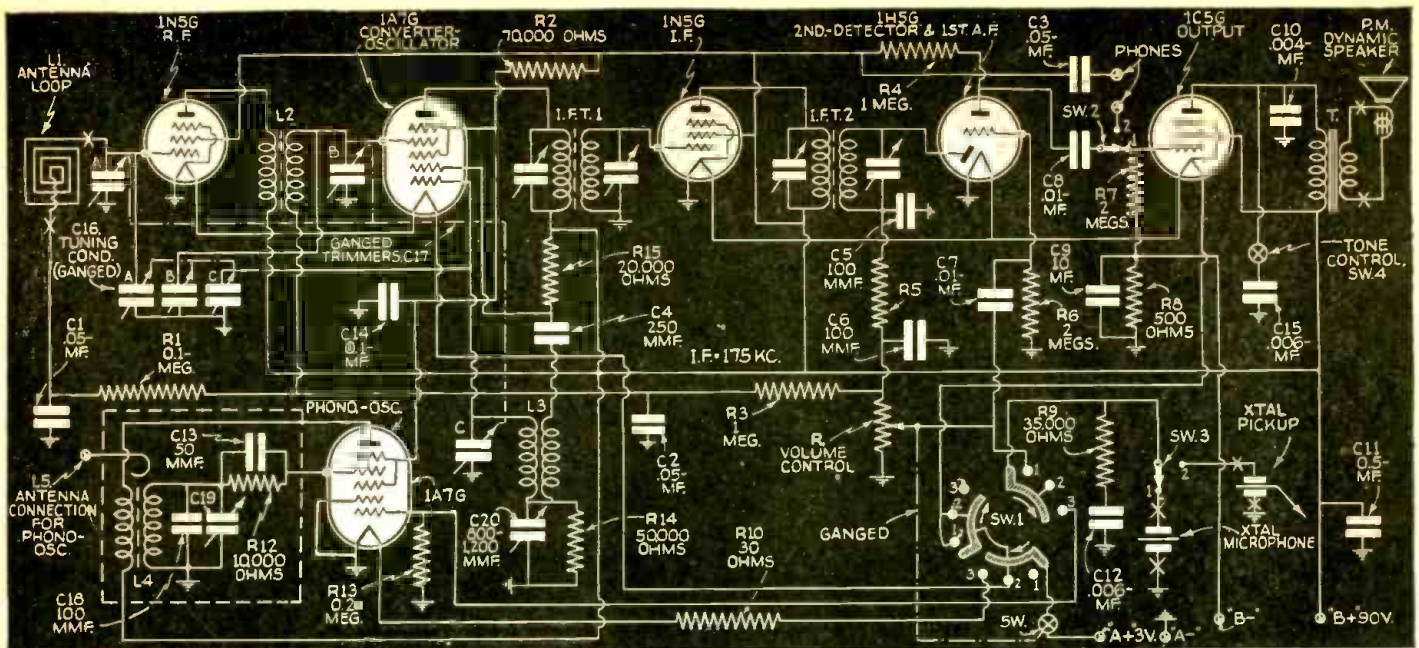

The new low-drain tubes for the first time make feasible such an instrument as the Ideal 6-Tube All-Purpose Battery-Operated Portable shown by diagram above. If you don't want to build it yourself, why not have it built for you? It's one of the most useful devices we've ever encountered.

### RADIO CHASSIS

The chassis proper is bent out of 36/1000-in. sheet steel, cut to 10 x 11 31/32 ins. Bend down 1 31/32 ins. with a brake or between blocks, leaving a top surface of 10 x 11 ins. The R.F. sub-base from the same material is cut to 9 7/8 x 2 1/2 ins. Before bending cut out the 1 1/8-in. socket holes, the 1st center 3/4-in. from the turn-down end. Then, 3 3/8 ins. from the 1st center, drill the 2nd hole. And 3 ins. from the 2nd hole, drill the 3rd hole. Then with a No. 30 drill, drill the socket mounting holes with 1 1/2-in. centers.

Punch out 3/4-in. holes for R.F. and I.F. coil leads, the 1st 2 5/16 ins. from the turned-down end, the 2nd 3 1/4 ins. from the 1st, and the 3rd 3 ins. from the 2nd. The R.F. coil hole is 15/16-in. from the top edge. Both I.F.'s are 15/16-in. from the top edge. The dimensions for the mounting lug holes may be taken

directly from the coils. Now turn down to a right-angle 17/32-in. to form the riveting bracket. Five holes size No. 30 should be drilled 3 13/16 ins. from the motorboard side of the main chassis equal distances apart. Drill corresponding holes in the R.F. bracket sub-base.

The audio sub-base is bent out of a 6 1/2 x 2 1/2 in. piece of the same material used above. Two 1 1/8 in. holes are punched for the 1st audio-diode and out-pump tubes.

Draw a center line for socket holes 31/32-in. from either long edge and mark off No. 1 center 1 1/8 ins. from case cover end; and No. 2 center 2 ins. from No. 1. Locate socket mounting holes for No. 30 drill which have 1 1/2 in. centers. Bend up at right-angles 3 3/8 ins.; use as the "B"-battery guide and support. Next bend to right-angles 17/32-in. to form the riveting bracket. Drill 3 holes

in same, with No. 30 drill, spaced evenly at either end and center. Drill corresponding holes 3 13/16 ins. from the left side facing the front of the case and to the rear of the main chassis. Drill 1 No. 26 hole to the rear and chassis edge for connection for the head-phone and radio coupling condenser lead. After riveting both R.F. and audio sub-bases in place, cut a rounded edge with tin snips corresponding to the radius of the case.

Earphone tip-jack holes are located 1/4-in. from one edge and 1 1/2 ins. from the other. Mount S.P.D.T. switch as near to the corner as is possible.

The "A" supply and volume control cable hole is drilled 3/8 x 5/8-in. from the corner.

### PHONO-OSCILLATOR CHASSIS

For the phono-oscillator ("wireless" phonograph) and record bumper chassis, cut a piece of sheet steel 7 3/8 x 7 3/16 ins. Then 3 1/4 ins. from either long side, fold the material back upon itself to form the record bumper. Next, bend the folded piece out at right-angles 3/4-in. from the folded edge, which forms the panel for the phono-oscillator coil and selector.

Turn up the 3/8-in. strip of the phono-oscillator panel nearest the gang side at right-angles. This will clear the gang rotor and form protection for the gang plates. Drill two 5/16-in. holes for trimmer shaft and screw on center line 3/4-in. from folded edge. First hole is 3/8-in. from the gang edge. Locate others from phono-oscillator coil. Drill hole for phono-osc. antenna tip-jack 1 x 2 1/2 ins. from corner. Drill 4 holes on main chassis side of this sub-base with No. 26 drill to clear a 6/32 drive-screw. Drill corresponding holes in the main chassis with No. 33 drill to mount sub-base to main chassis. Bend up triangular single socket sub-base 3 1/4 x 2 1/2 ins., leaving outside of these 3/8-in. on the 2 panel sides for riveting. These are bent at

(Continued on page 54)

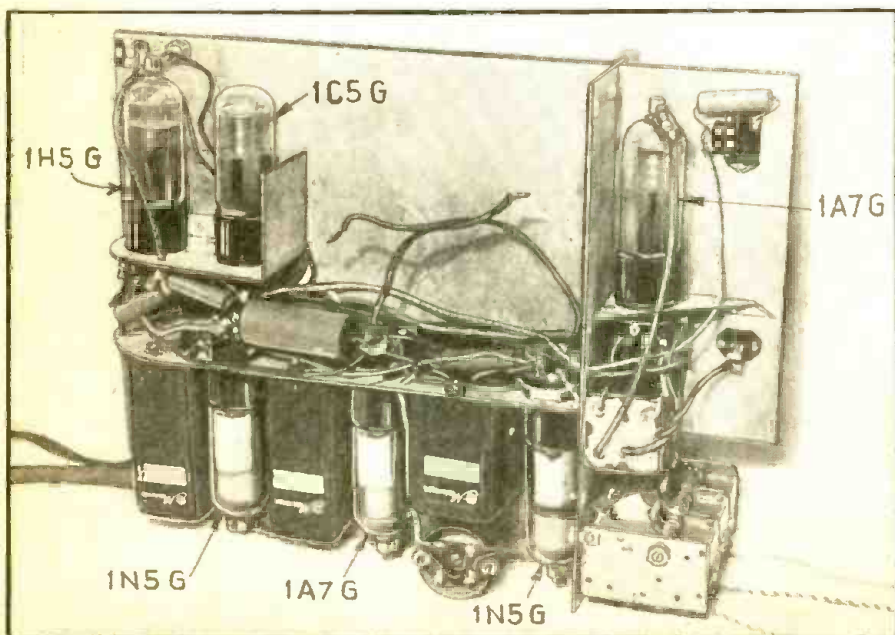

Here's the way the radio and sound equipment shapes-up. Simple as A-B-C, yes, but it represents the expenditure of much midnight electricity before all the bugs were eliminated, and the authors could say, "Here it is—go to it!"



# TUNING WITH A RHEOSTAT!

The authors,—writing originally in Funk Technische Monatshefte (Berlin, Germany), from which this article was translated and briefed by RADIO-CRAFT, —tell experimenters how powdered-iron, used as a core material, increases a coil's inductance, and how an electromagnetic field reduces this inductance to an air-core value. Television may eventually benefit from this system.

PROF. G. LEITHÄUSER and H. BOUCKE

**H**ERE is a remote tuning control which operates perfectly without recourse to moving parts or complicated mechanical components, such as variable condensers!

The main trick of its operation consists simply of varying the strength of a small amount of direct current and thus the inductivity of the tuning coil of a converter unit (remote-control input stage) located on the roof of the home. The purpose of locating the converter on the roof is to provide more static-free reception, especially in cities, by improving the signal/noise ratio: 1st, by eliminating long transmission lines carrying R.F., and 2nd, by delivering a strong, preamplified signal, at I.F., to the transmission line. These general principles have been discussed in past issues of *Radio-Craft* in connection with "centralized radio systems"; our especial interest in this article, on the other hand, lies in the novel and useful manner in which this unit on the roof may be tuned from downstairs by varying a field-coil current.

## FIELD CURRENT

This current is sent through the turns of a standard A.F. choke of low resistance, of which the iron core has partly been "cut away" (see Fig. 1), leaving us, in principle, an electromagnet of U-form. Between the "poles" of our "electromagnet"—pardon me, A.F. choke (marked as unit 2 in Fig. 1), has been inserted an R.F. transformer with iron core of similar design as used at present in car-radio receivers. The primary of

this R.F. transformer is connected to the antenna.

When current is sent through the turns of our "electromagnet" an electromagnetic field will be created between its "poles." The strength of this field depends of course upon the strength of the current sent through the turns of the A.F. choke. Now, let us see what happens when an R.F. coil with iron core is placed into the magnetic field of an electromagnet.

## "FIELD-COIL TUNING"

Remember that stations may be tuned-in by varying *either* the capacity or the inductance of the coil, let's see what can be done if we concentrate on the latter idea.

A scheme we here utilize takes advantage of the not widely known fact that the inductance of a coil may be reduced by placing an R.F. coil with iron core into a strong magnetic field. This seems quite novel especially since we know that many contemporary receivers are equipped with R.F. coils containing "R.F. iron" in order to INCREASE the inductance of a coil. But in our case the increase of inductance (as caused by the inserted iron core) is *neutralized* step by step, by the influence of an electromagnetic field.

*Or said in other words, the inductance of the coil may be decreased by the application of a separately created field, and the decrease effected may be as large as to give the coil an inductance value as large or small as it was before* (Continued on page 51)

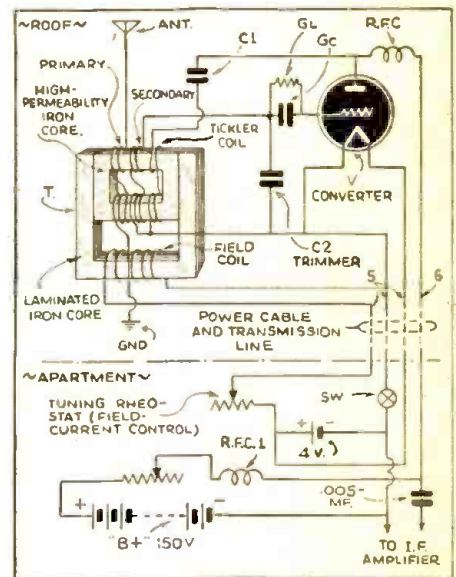

Fig. 1. Elementary converter (roof unit).

## EDITORIAL COMMENT

Although the authors of "Tuning with a Rheostat" have developed their story around the application of resistance tuning to the remote tuning of an anti-noise antenna installation, the principles involved are applicable in any tuned circuit.

In fact, the use of resistance tuning as a means of tuning-in stations between the settings of stations tuned-in by means of push-buttons, as illustrated in Fig. 3, may be extended to include resistance tuning over the entire receiving range. We particularly call attention to the following articles in recent issues of *Wireless World* (London, England): "Magnetic Tuning and Single Span," and "Magnetic Tuning Devices," by L. de Kramolin; and, "The Wobbly Oscillator—Magnetic Control for Frequency Modulation," by J. H. Reyner.

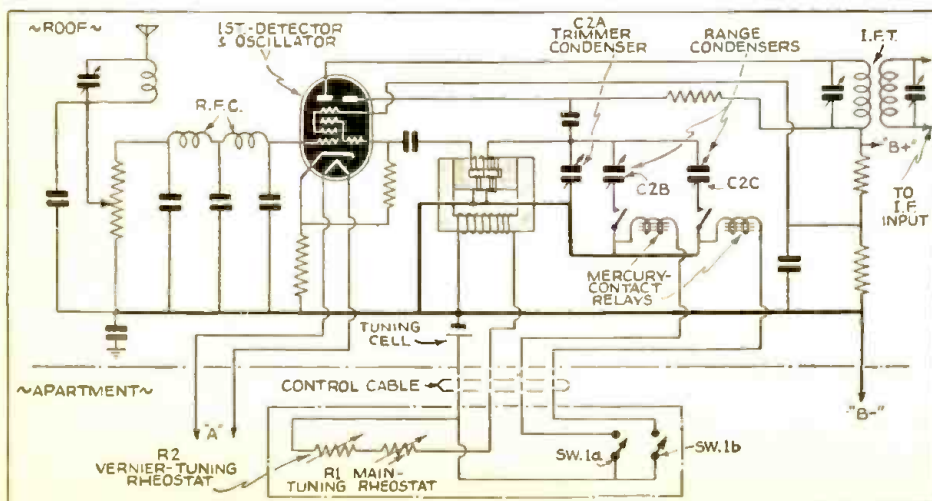

Fig. 3. Complete schematic circuit of an improved converter. This unit mounts on the roof of a home and feeds a "clean" or static-free I.F. signal into the remainder of the superhet. receiver, which is located, together with station-selecting pushbuttons and the inter-station tuning unit (a rheostat!), in a room downstairs.

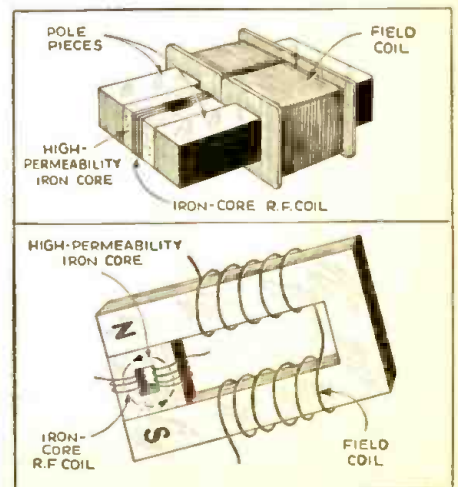

Fig. 2. Tuning by means of a rheostat involves varying a field current. The wavelength change is greatest at short wavelengths.





The first all-electronic orchestra—conducted (with the aid of a bank of electronic controls) by Tom Adrian Cracraft. Each instrument uses a separate loudspeaker working through a main control desk. This permits the monitoring and individual expression of instruments. The orchestra is here shown in practice.

# Announcing!—THE ELECTRO-ORCHESTRA

*Steinway Hall (New York), last month witnessed the epochal première of the Cracraft Electronic Orchestra, directed by its 35-year-old organizer and impresario. Pioneering in collaboration with the author, he has found ways for the vacuum tube to revitalize the music industry by means of Electronic Music.*

In the April 1938 issue of *Radio-Craft* the present writer described an Electronic Orchestra made up entirely of *electronic orchestral instruments*. In this plan each instrument utilized a separate loudspeaker near the player, and over which the conductor exercised, through a control unit, supervisory volume control, for the setting of balance among the various instruments' tone powers, and for overall dynamic monitoring and expression.

Such an orchestra has been formed with my assistance, and directed by Mr. Tom Adrian Cracraft. It has been rehearsing for some time in New York. It comprises several violins; a violoncello; a string bass;

**BENJAMIN F. MIESSNER**



a guitar; a 13-tone, chromatically-tuned kettle drum; a Super Electone piano giving practically all percussive, plucked string, and wind instrument tones under keyboard-touch, dynamic control; and, a Novachord, which gives also a wide range of instrumental tones but without this keyboard touch control of individual tone dynamics. His orchestra is shown above (arrow points to conductor's "swell" or volume-control pedal).

This type of orchestra is suited for general use, in auditoriums, and where microphones are used for public address augmentation, for broadcasting, recording, etc.

*(Continued on page 50)*

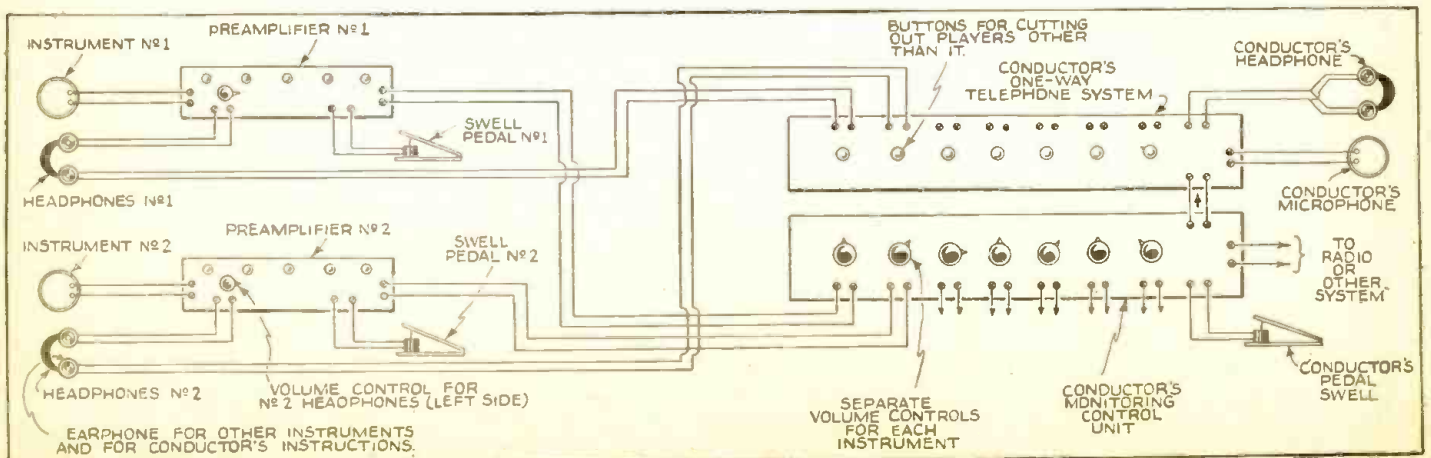

Block diagram showing the coordination of preamplifiers, main amplifiers, control desk, swell pedals, etc. of the first completely-electronic orchestra. The swell pedals are operated by foot. The Electronic Orchestra opens an entirely new field for employment of large numbers of musicians!



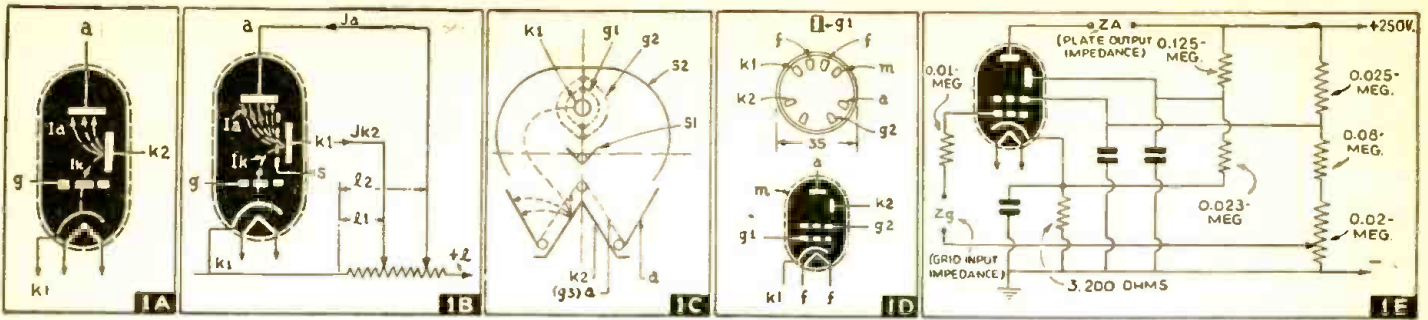

Fig. 1. (A) Generation of secondary electrons. (B) The auxiliary grid *s* supports the formation of secondary electrons and suppresses leakage. (C) Arrangement of the electrodes in the new tube. (D) Arrangement of the socket of the new tube. (E) wiring of the tube as a television intermediate-frequency amplifier.

# A NEW Secondary Emission TUBE

The A-B-C of "secondary emission" is discussed by the author. The analysis is continued, step by step, until an entire, new tube construction has been discussed, and its operation in various types of circuits analyzed. The author, a resident of Paris, France, submitted the article to RADIO-CRAFT written in German; translation is by Alphons Summit.

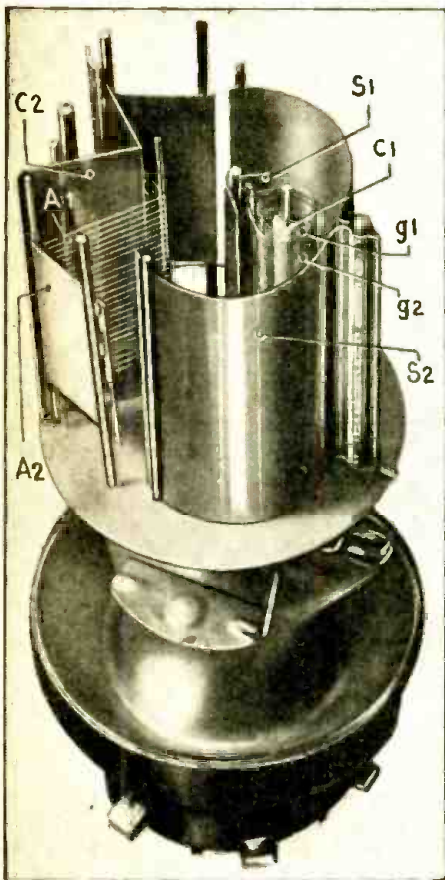

Fig. A. New Secondary Emission tube. Reference letters compare with Fig. 1C (C and K are the same).

**R**ADIO engineers have been able to produce a new, very interesting and quite unique, tube. This tube makes it possible to solve at once a number of difficult problems regarding amplifiers and wiring. It is true that the principle of utilizing secondary electrons produced at will is not new. However, the new tube produces results which are worth a detailed description.

## SECONDARY ELECTRONS

In an electronic tube containing 2 electrodes (anode and cathode), electrons

bounce against the anode, under the influence of a high anode voltage. These electrons can penetrate the atomic structure of the anode material and split several atoms. Thus new electrons are torn away from the nucleus of their atoms and are liberated. These new electrons are called *secondary electrons*.

These secondary electrons are usually, if no special care is taken, again absorbed immediately after their production by the anode (or plate), as the anode strongly attracts the negatively charged electrons.

An accumulation of richly produced secondary electrons may lead to a so-called negative charging of space. This charging may impede the flow of electrons on their way from the cathode to the anode. The elimination of this impediment is effected by the usual arrangement of special auxiliary electrodes which are known as control-grids (space-charge grids).

By special wiring of the electrodes one can make it possible that the electrons which emanate from the cathode K1 hit the positively charged electrode K2 in such a manner that the secondary electrons which are released hereby, really are liberated, and that they are attracted by a still higher positively charged electrode *a*. (See Fig. 1A.)

(Note that electrode K2 referred-to in the text is incorrectly identified in Fig. 1B. K1 Electrode shown as delivering current JK2 is actually the electrode referred-to in the text as K2.—Editor)

## SUITABLE K2 COATINGS

Certain materials, for instance, nickel, do not easily release secondary electrons. If nickel is used, the flow of secondary electrons is about 6% smaller than that of primary electrons.

There are, on the other hand, metals and rare minerals which produce much more favorable results. If these materials are used, the flow of secondary electrons is always several times that

## HANS FASAL

of the primary ones.

Upon this effect the principle of the new amplifier is based.

The release of secondary electrons can to a great extent be influenced by introducing auxiliary electrodes which accelerate the flow of electrons and eliminate charging of space and other harmful influences. This is shown in Fig. 1B.

The additional grid *s*, which is connected with the same potential as *a*, speeds up the flow of the primary electrons. They hit upon K2 at an accelerated pace. The secondary electrons cannot, as heretofore, return to K2, as they are attracted by the higher positively-charged *s*. They pass through *s* on account of its wide meshes, and are finally attracted by the flat anode *a*. Leakage is practically eliminated, as the auxiliary grid *s* has the same potential as the anode, and, besides this, electrons always take the shortest route. On the other hand, the small percentage of secondary electrons aids the anode current, which current is directly caught by the acceleration grid *s*.

The electrode K2, if arranged as in 1A and 1B, is called a *cold cathode*.

## ATOMIC THEORY

According to the atomic theory, the so-called *neutral atom* is an equilibrium between positive and negative electric quantities. If certain quantities of negative electricity are eliminated from a neutral atom, the remaining part of the atom becomes more positive. Thus, in Fig. 1B, the flow of electrons away from the cold cathode K2, will result in a flow of positive electricity towards the source of voltage *e*. The flow within this circuit seems to be opposite to that within the anode circuit. If, for instance, an electron which hits K2 releases 5 secondary electrons, the current JK2 is equal to the effective flowing-away of 4 positive electrical units, whereas the current *Ja* gains 5 positive electrical units, *Ja* is thus 15-20% above JK2.

(Continued on page 54)





The 10-W. All-Push-Pull Direct-Coupled Amplifier. Note its simplicity, and compactness. A view underneath the chassis will amaze you with its scarcity of components.

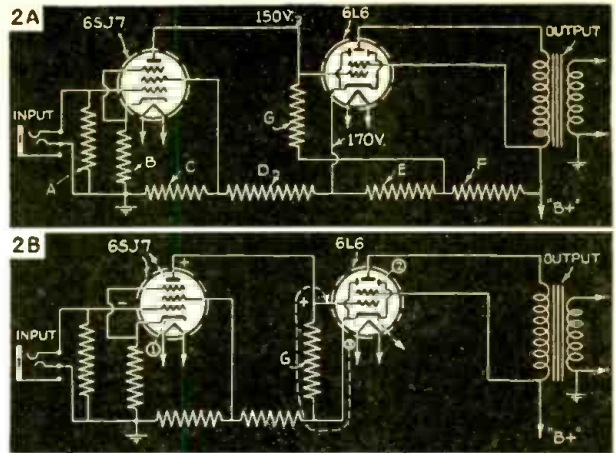

Fig. 2. In (A) is shown the basic diagram of a direct-coupled circuit; and in (B), old method for obtaining grid bias for output tube.

# How To Design ALL-PUSH-PULL DIRECT-COUPLED

An engineer takes you into the laboratory to show you how ideal amplifier pertubes give new impetus to the direct-coupled amplifier made famous by Messrs.

A. C.

WITH the present-day high development of engineering skill and manufacturing technique, it is possible to build into an amplifier an exaggerated characteristic along almost any line that one can name. Such an accomplishment, as a matter of fact, is not merely so difficult, as the designing of a product in which there is a well-balanced relation between the various aspects of performance, dependability, power output,

### Dear Editor:

The results of our laboratory measurements made on the All-Push-Pull Direct-Coupled Amplifier, which is described in the accompanying article, have amazed me and my associated engineers.

You will note that I have intentionally failed to supply you with a frequency response curve of the essential amplifier, inasmuch as I want to avoid the slightest possibility of being accused of placing a straight edge upon a graph sheet and drawing a straight line.

(Continued on page 59)

at the same time, ALL-PUSH-PULL operation is obtained.

It is also well known, that *direct-coupling* overcomes objectionable characteristics of transformer coupling (core saturation, magnetic lag, and transformer resonance) and resistance coupling (short-circuiting of weak signals and grid blocking of strong signals). Furthermore, it is unsurpassable from a simplicity standpoint (Only 9 resistors and the usual output transformer plus filter supply are required to attain extraordinary results!).

The question may well be raised, "If this type of a circuit is so extraordinary, why is it not more popular?" The an-

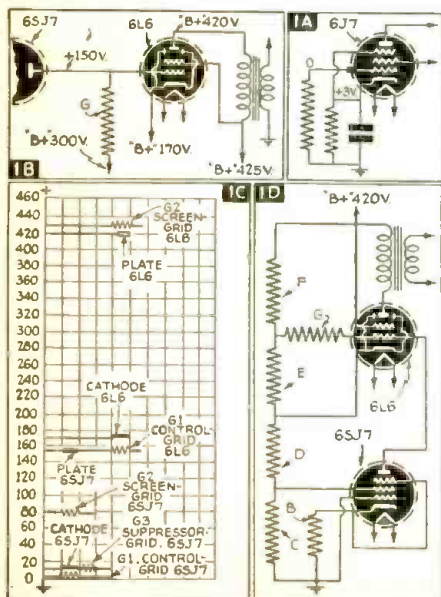

Fig. 1. (A) The actual distribution of bias voltage in a conventional amplifier stage; (B) voltage distribution system in a fundamental direct-coupled circuit; (C) voltage distribution, graphically illustrated; and (D) direct-coupled amplifier circuit graphically illustrated.

weight, economy, and simplicity.

### WHY THE "DIRECT-COUPLED" AMPLIFIER?

If the ideal attributes of a perfect amplifier were to be carefully tabulated and checked against features offered by various amplifier circuits, it would be found that a direct-coupled amplifier will fit all of the conditions and will lead, by a wide margin, the very finest resistance-coupled, impedance-coupled, or transformer-coupled units.

The advantages of Direct-Coupled Amplifiers were known for a great many years, but the inability to attain a simple and practical *direct-coupled inverter*, in order to achieve push-pull output and its many attendant advantages, offered a serious handicap to the popular use of this circuit. Although a successful Direct-Coupled Inverter Circuit was developed by the writer about 2 years ago (see March, April, and July, 1937 issues of *Radio-Craft*), it required a special output transformer, and did not follow extreme simplicity of design. A new circuit (see Fig. 3) removes the last objection to the popular use of the ideal Direct-Coupled Amplifier for all applications;

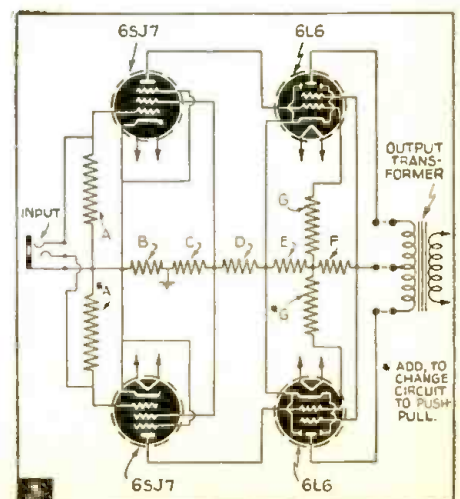

Fig. 3. Basic push-pull direct-coupled circuit. Note that only 2 extra resistors are required to change the circuit from a basic single to basic push-pull.



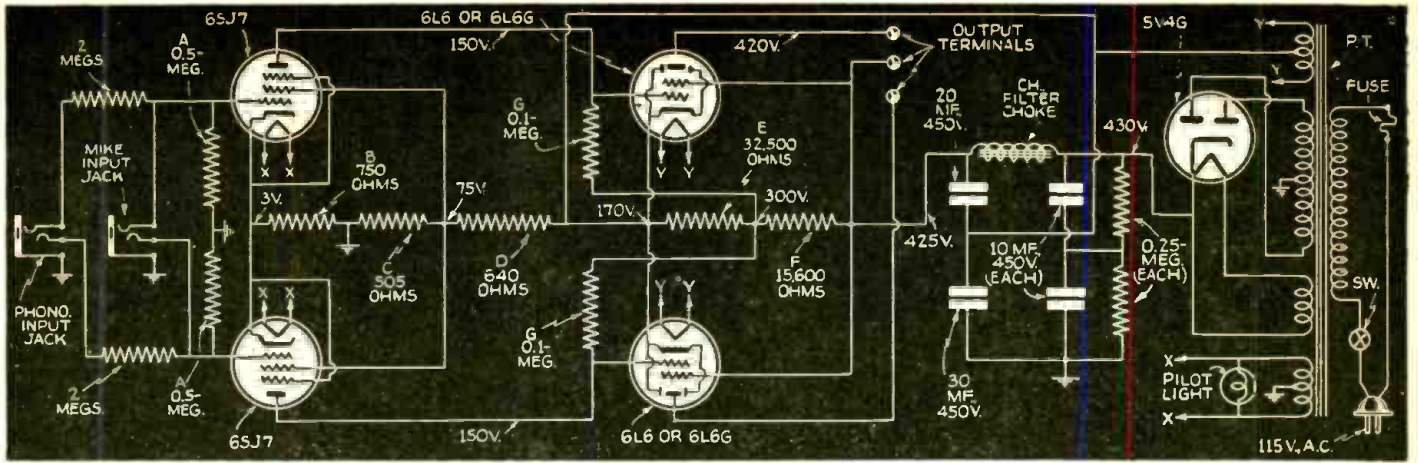

Fig. 5. Complete schematic diagram of the 5-tube, 10-W., All-Push-Pull Direct-Coupled Amplifier illustrated on the opposite page.

# An Inexpensive 10-WATT AMPLIFIER

formance is attained in a practical and economical twin-channel unit. New Loftin-White; and make possible a phase inverter-less ALL-PUSH-PULL circuit.

## SHANEY

swer is found in the usual objections offered to direct-coupled circuits, plus the fact that because of its unusual arrangements it had not received deserved attention from design engineers.

The usual objections to the Direct-Coupled Amplifier are:

- (1) Tricky circuit.
- (2) Instability.
- (3) High voltages required.
- (4) Critical hum-balancing adjustments necessary.
- (5) Variations of characteristics in similar-type tubes affect voltage distribution within the amplifier.

All of these objections have now been completely eliminated. In fact, an understanding of the design principles involved (which are covered in detail in

### Applications

- High-Fidelity P.A. Amplifier
- High-Fidelity Phono Amplifier
- Laboratory Standard Amplifier for comparing microphones, speakers, pickups, etc.
- Twin-Channel Amplifier
- Constant 2-Way Communicator
- Switchless Recording and Playback
- Amplification in auditory perspective
- Reproduction of artificial echo and reverberation
- Replacing amplifier section of radio receivers, where high-fidelity performance is desired
- Amplification of musical instruments
- General replacement of obsolete amplifiers

this article) in engineering an amplifier of this type, will convince the greatest skeptic, that its performance, dependability, economy, and simplicity could not be surpassed.

### SOLVING PROBLEMS

1st—In the 1st place, no circuit can be more fundamentally simple than direct-coupling. Anyone who objects to tricky circuits, confesses his lack of understanding of the circuit operation. It is a well known fact, that some of the greatest feats of magic are amazingly simple, once their operating principles are understood. A study of the design principles involved, and which are given here, will prove this point about Direct-Coupled Amplifiers.

(Continued on following page)

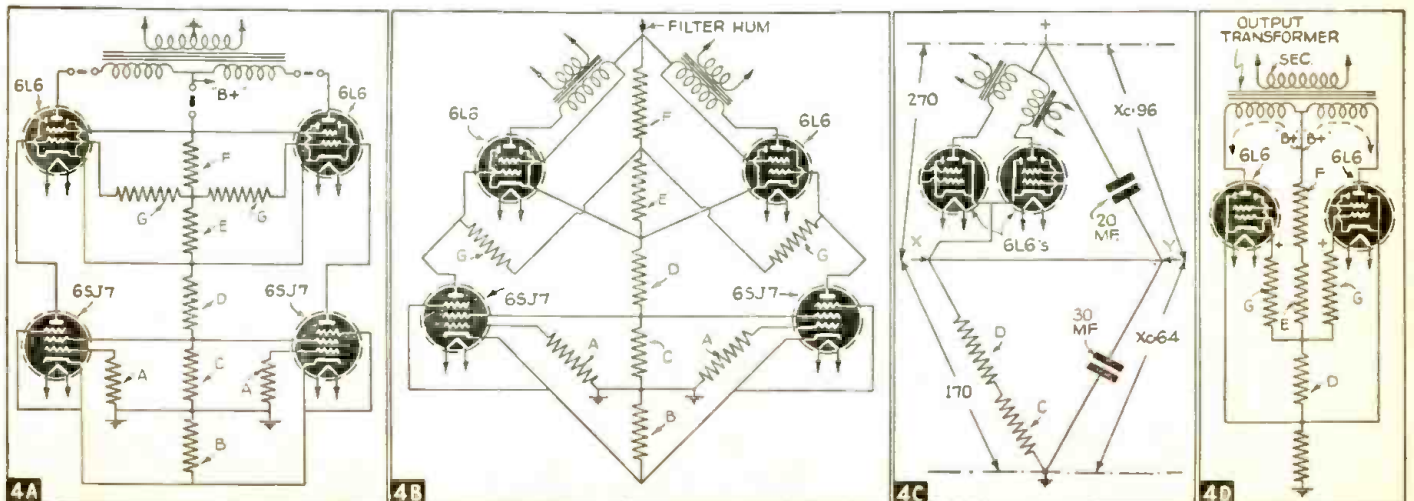

Fig. 4. (A) Showing symmetry of circuit and derivation of hum-cancelling bridge circuits. (B) Showing complex hum-balancing, signal-balancing and voltage-balancing circuits. (C) Hum-balancing filter network. (D) Showing how hum is balanced in push-pull output transformer.



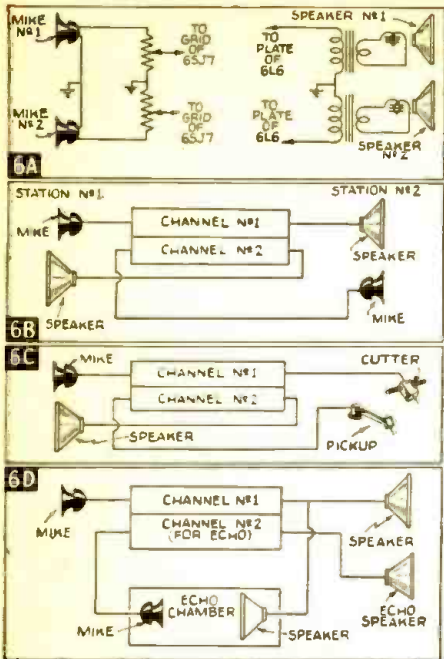

Fig. 6. (A) Circuit for auditory perspective. (B) Two-way communication system. (C) Switchless recording and playback system. (D) Artificial reverberation (echo) system.

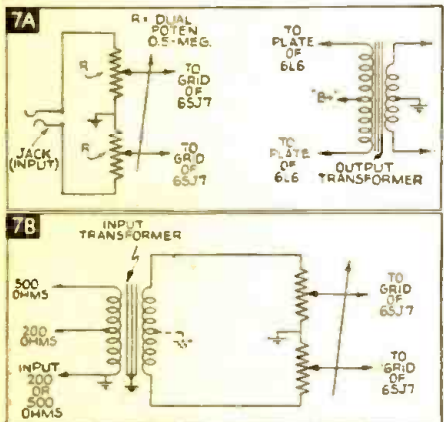

Fig. 7. (A) Push-pull input and push-pull output of a direct-coupled amplifier system. (B) Push-pull input connection.

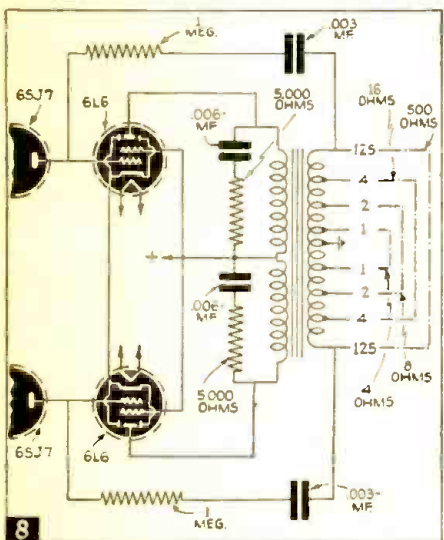

Fig. 8. Push-pull inverse feedback and compensating network for high fidelity results with economical transformer. The inverse voltage is derived from the 500-ohm taps on the secondary of the output transformer (which, incidentally, except for the power transformer is the only transformer in this amplifier). The center-tapped primary of this transformer connects to the 3 terminals in Fig. 5 marked OUTPUT TERMINALS. Note that, at mailorder prices, all the parts required for this amplifier should not cost you over \$10!

2nd—In the 2nd place, complete stability of this circuit is attained by applying stabilized and self-balancing voltages to control elements.

3rd—In the 3rd place, the highest voltage required for this particular amplifier is approximately 430 volts. It is indeed simple, to safely handle this voltage, by using two 450-volt condensers connected in series. Such a combination will handle 900 volts, and makes available a safety factor of 100%, which exceeds, by far, safety factors employed in usual commercial amplifiers.

4th—In the 4th place, critical hum-balancing adjustments are no longer required in a truly all-push-pull direct-coupled amplifier, inasmuch as all filter hum voltages automatically cancel themselves. This is further clarified in the design principles which follow.

5th—In the 5th place, variations in characteristics of similar-type tubes will not detrimentally affect the distributed potentials within the amplifier, as any such unbalance between corresponding tubes will automatically tend to produce equivalent unbalance in its adjacent channel.

#### FUNDAMENTAL DIRECT-COUPLED CIRCUIT

To really understand the operation of a direct-coupled amplifier, it is necessary to realize that its basic principle depends upon the direct connection of a plate of an input tube to the grid of an output tube. Both of these elements have the same applied potential, but suitable corrections are applied to the output tube so that the effective bias and plate voltages are in conformance with standard ratings. To understand this condition, let us analyze a conventional bias circuit (as shown in Fig. 1A) in a 6J7 pentode tube. For a negative bias of 3 volts, a resistor is usually inserted in series with a cathode circuit, so that a positive potential is developed at the cathode. In actuality, there is a zero potential at the grid (as measured from ground), and a plus 3 volts from ground to cathode.

We say that a negative bias of 3 volts is applied to the grid. However, if an analysis of this circuit is made, the following conditions are apparent:

If we look into the tube from the cathode to the grid, we "look down 3 volts," so that the voltage distribution within the tube is of such a nature, that it may be construed as -3 volts on the grid (as compared with the cathode). If, however, we look into the tube from the grid to the cathode, it may be construed as +3 volts on the cathode (as compared with the grid). This might appear to be a tricky circuit to one who is unfamiliar with this type of biasing. The average radio man, however, takes this circuit for granted, and probably gives it no thought.

In the same way, voltages are distributed within a direct-coupled circuit (as illustrated in Fig. 1B). It will be noted that 150 volts is applied to both the plate of the input tube, as well as

to the grid of the output tube, but 170 volts is applied to the cathode of the output tube so that the effective bias (looking from cathode down to the grid) is 20 volts. Although the plate potential is 420 volts (from ground) its effective potential is only (420-170) 250 volts, as measured from cathode to plate.

#### INITIAL DESIGN CONSIDERATIONS

The first step in the design of the Direct-Coupled Amplifier, is to determine (a) power output required, (b) highest voltages desired in the filter supply, and (c) the necessary gain. Let us assume that our specifications call for the following conditions:

Power Output: 10 watts with less than 2% total harmonic distortion;

Filter Supply Voltage: Not to exceed 450 volts (to avoid excessively high voltages, and assure adequate safety factor of any filter design);

High Gain Input: 90 db. (to operate in conjunction with medium-level microphones);

Medium Gain Input: 70 db. (for crystal pickup or radio set).

A cursory examination of available tubes would lead us to select two 6L6's

for the output stage, operating with 250 volts on the plate and screen-grid, which according to standard ratings, will develop approximately 14 watts at 2%.

Allowing for a 5-volt drop in the filter choke, a 5-volt drop in the output transformer, plus a 250-volt drop in the output tube, and an additional 20-volt bias drop to grid, there is available approximately 150 volts for the plate of the input tube. A 6SJ7, operating as a pentode with approximately 150 volts on the plate and 75 volts on the screen-grid, will satisfy our conditions for gain.

For medium gain, an additional attenuator is placed in the input circuit to drop the input signal 20 db., so that a crystal pickup can be easily accommodated.

If we list the tubes and their corresponding applied potentials, we have the essence of our Direct-Coupled Amplifier.

Electrode	Operating Conditions For	
	6SJ7	6L6 (or 6L6G)
Plate Volts (E <sub>p</sub> )	150	250
Control-Grid (Ec1)	-3	-16
Screen-Grid (Ec2)	75	255*
Suppressor-Grid (Ec3)	0	—
Av. Plate Current (I <sub>b</sub> )	1.5ma.	65ma.
Screen-grid Current (Ic2)	0.5ma.	6.5ma.

(\*We anticipate a 5-volt drop in the output transformer, so that the screen-grid potential will actually be 5 volts higher than its plate. This normal condition does not affect the performance of the amplifier in any manner.)

Although we will finally develop a push-pull amplifier, the element poten-

(Continued on page 57)





# NEW TUBE TESTERS

## For Checking the High-Voltage-Filament Tubes

Here's an exclusive article on how one tube tester manufacturer overcomes the problem of new 70- and 85-volt filament tubes, and provides for any future filament voltage from 1.5 to 110 volts. A filament "Varivolt" selector does the trick.

SAMUEL C. MILBOURNE

Service Engineer

**W**HEN, in the course of radio tube developments, a trend is indicated by laboratory developments and later confirmed by commercial announcements. test equipment manufacturers have one of 3 courses open: (1) ignore the trend until they are forced to bring out new tube testers capable of checking the new tubes. (2) withdraw existing models until new tube testers can be developed to take care of the new tubes, or (3) immediately develop and incorporate such new parts and circuits in existing models as to not only cover the few tubes first announced. but adequately cover any possible FUTURE new tube types.

### WHEN "OCTALS" CAME

Some few years ago, tube perfection was considered to be at about its zenith by the general run of radiomen. Tube testers were designed with 4, 5, 6, small 7 and large 7 prong sockets and then—it came! The OCTAL tube threw a temporary monkey wrench into the tube tester industry and, overnight, tube testers without an octal socket or two were definitely not in demand.

The then general plan on octal tube testers was to add an octal socket and possibly one other spare socket in case future tube terminations were to require it.

This was, in the opinion of Supreme engineers, a half-way solution to the problem. They kept asking themselves, "Suppose tubes were later announced with tube terminations switched around? Suppose tube filament terminations started to roam?"

Where would the tube tester with just one spare socket be if many tube termination changes should occur?

As a result, they invented and pioneered the FILAMENT RETURN SELECTOR and associated circuit as shown in Fig. 1. With this advanced design it made no difference where tube elements terminated. The user could, by setting switches, automatically connect any and every tube element to its proper test circuit regardless of where the element terminated on the tube base!

What is more, they did not hold this back until the inevitable roaming filament terminations on new octal tubes forced them to use it. It was given the service industry from the first and has proved its value time and again by keeping roaming filament terminations from obsolescing tube testers.

Fig. 1. Here's how the filament terminals of the several tube sockets in the Supreme model 504 unit connect to the voltage selector system.

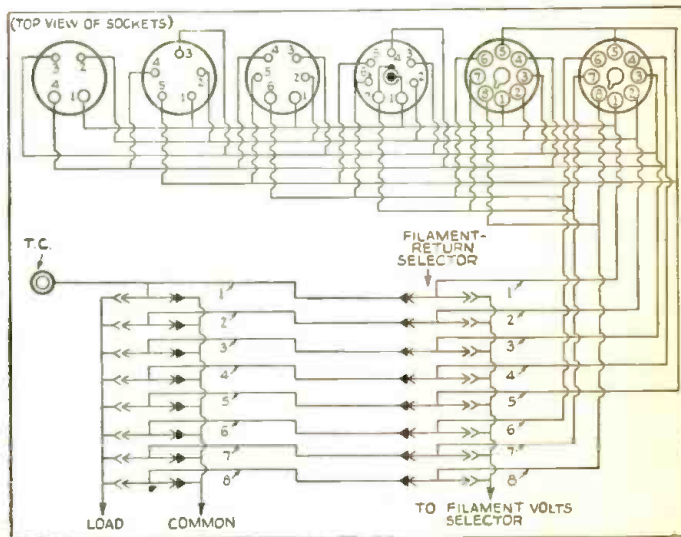

Remember, since the advent of the octal tube, filaments have terminated on No. 2 and No. 7, No. 2 and No. 8, No. 7 and No. 8, No. 2 and No. 3, several additional types have had center-tapped filaments with several other types having no filament at all. The announcement of the octal tube added another filament termination type—No. 1 and No. 8.

Recently, tubes with filament voltages above 50 volts were announced. Previously, 35- and 50-volt tubes were designed; 70- and 85-volt filament tubes are now appearing. Future tubes may be designed for any filament voltage up to 110 volts! Once more, test equipment manufacturers must decide whether to ignore or include facilities for their test.

### FILAMENT VOLTAGE SELECTOR

The answer to present and future filament voltage problems is the new FILAMENT VARIVOLT SELECTOR circuit which has immediately been incorporated in both the 503 Tube Tester and the 504 Tube and Radio Tester (photo). A total of 23 available filament voltages gives complete coverage of all past, present and future filament voltages. Taps at 1.5, 2, 2.5, 3.3, 5, 6.3, 7.5, 12.6, 15, 25, 35, 50, 55, 60, 65, 70, 75, 80, 85, 90, 95, 100 and 110 volts give positive assurance against high-voltage filament obsolescence! Figure 2 shows the new Filament Varivolt Selector circuit. A 2-pie switch is used for filament voltage

(Continued on page 49)

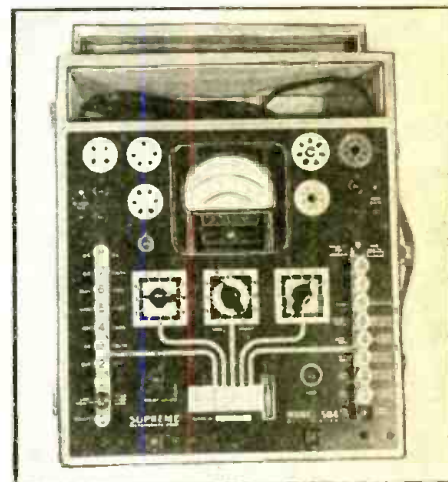

The Supreme model 504 Tube and Set Tester, which features a new "Filament Varivolt Selector."

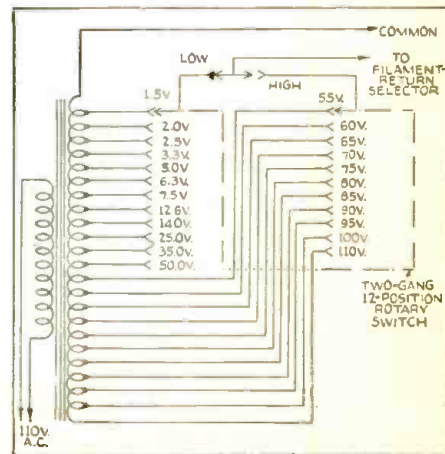

Fig. 2. The filament transformer is tapped in steps from 1.5 V. to 110 V. (the latter taps provide for future tube types).



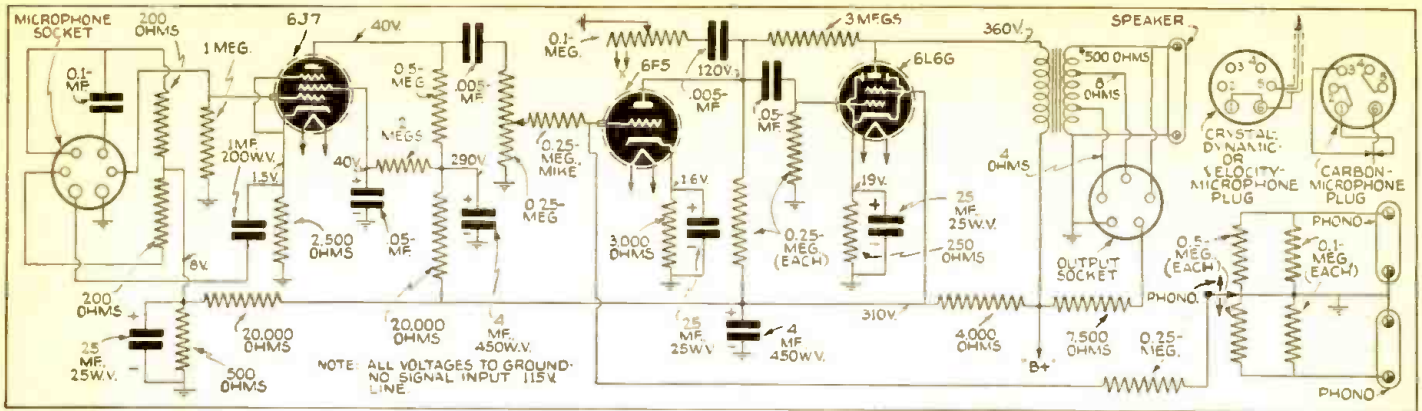

Fig. 1. Schematic diagram of an 8-W. amplifier incorporating several modern circuit features.

# LATEST CIRCUIT FEATURES

## In Modern Public-Address Amplifiers

What makes this year's amplifiers different from those of last year? What are the advantages of these innovations and changes? In this article two writers collaborate to present to RADIO-CRAFT readers many informative answers to these pertinent questions insofar as they relate to new models in one well-known make of amplifiers.

L. M. FEILER and M. N. BEITMAN



8-Watt Amplifier

**T**HERE is a constant stream of new developments in Public Address amplifier circuits . . . improvements for better fidelity, greater ease of operation, lower cost and better overall efficiency. What really new developments have been included in the present equipment?

**Versatile Inputs.** In Fig. 1, is the schematic diagram of a low-priced 8-watt amplifier. On first examination, the circuit appears to be of the regular type, but we notice some interesting differences in the microphone input section.

A special input circuit permits the use of any single-button or double-button carbon microphone, or any crystal or dynamic high-impedance type microphone. Let us see how this versatile application is accomplished.

Suppose a low-level crystal microphone is used. The plug employed for making the connection to the input has a jumper wire between the prongs 1-6 (filaments). This connects the shield of the input cable to ground and also places the 1 mf. bypass condenser across the 2,500-ohm cathode resistor. The "hot" side of the cable is connected directly to the control-grid of the type 6J7 tube. The 200-ohm resistors are not used with this arrangement.

If a double-button carbon microphone is used, the other plug employed has jumpers across the terminals 1-2 and 4-5. The micro-

### PART I

phone center-tap is connected to prong 6 (ground) while the other two connections are made to prongs 3 and 2-1.

About 8 volts filtered D.C. is developed between ground and the junction of the two 200-ohm load resistors. These load resistors match the carbon mike used, and the voltage supplies the required microphone current. One button is coupled to the grid, through the 0.1-mf. condenser while the other is coupled through the 1 mf. condenser to the cathode. (This 1 mf. is the same condenser used previously as a bypass.) Thus the algebraic sum of the voltage changes across the 200-ohm resistors is applied between grid and cathode.

**Medium-Level Mixer.** True electronic mixing requires a dual control-grid tube. An interesting form of mixer circuit can be obtained with a single triode tube and a special resistor network. This is used in the 8-watt amplifier circuit.

Notice that a ¼-meg. resistor is used in each of the input circuits. Actually this resistor creates a very small loss of the signal; but when the control for the microphone is reduced to the minimum signal setting, the grid is actually not at ground potential, but is separated from the ground by the ¼-meg. resistor in the equivalent circuit. The same sort of network exists when the phono volume control is set at zero and microphone input is used.

**High-Level Mixer.** This special mixing, of course, has its limitations in case the maximum gain of the mixer stage must be (Continued on page 53)

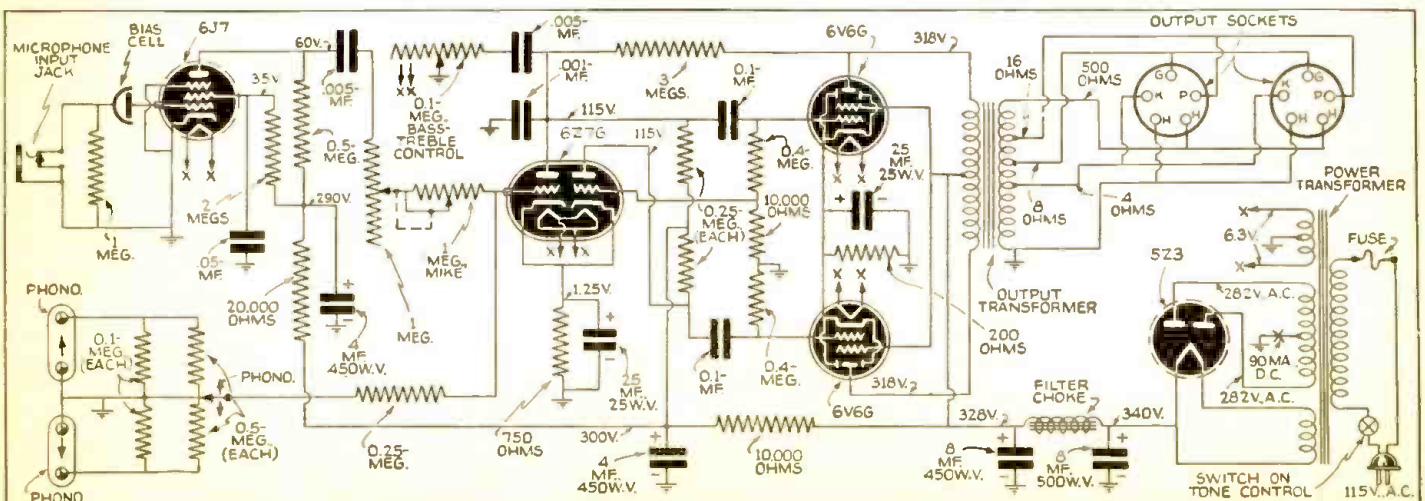

Fig. 2. Complete schematic diagram of an up-to-date 12-W. amplifier.



CINAUDAGRAPH  
CORP.

RADOLEK  
CO.

FOX SOUND  
EQUIPT. CORP.

ATLAS  
SOUND  
CORP.

# \$4,000 P.A. CONTEST

→ [THIRD MONTH] ←

## \$4,000 Worth of Prizes

(Approximately \$1,000 in prizes per month for 4 consecutive months)

will be given to

**SERVICEMEN, RADIO DEALERS AND  
SOUND SPECIALISTS**

for **BEST** letters describing

**ACTUAL PUBLIC ADDRESS SYSTEMS INSTALLED**

During the Past 8 Months and up to the End of This Contest

**OBJECT OF THE CONTEST**

**PUBLIC ADDRESS** is now on the upswing and all indications point to a bigger sound business this coming season. In order to stimulate interest at this time in public address *(Continued on page 40)*

AMPLIFIER  
CO. OF  
AMERICA

AMPLITONE  
PRODUCTS  
CO.

VOCAGRAPH  
SOUND  
SYSTEMS

MILES  
REPRODUCER CO.

MONTGOMERY  
WARD & CO.

ALLIED-  
BURNS  
COMPANY

LAFAYETTE  
RADIO CORP.

GERNSBACK'S  
OFFICIAL RADIO  
SERVICE MANUAL

EASTERN  
MIKE-STAND CO.

VAC-O-GRIP CO.

### LIST OF PRIZES

FIRST PRIZE—"Filmgraph" Model A, \$149.50  
*Offered by Miles Reproducer Co., Inc.*

SECOND PRIZE—Audio-Spectrum Control Add-On  
Unit, type ACA-ASC, \$100.00  
*Offered by Amplifier Company of America*

THIRD PRIZE—15-18 W. Complete P.A. System, \$89.50  
*Offered by Wholesale Radio Service Co., Inc.*

FOURTH PRIZE—25 W. de Luxe Amplifier, type  
AM-25, \$71.00  
*Offered by Amplitone Products Company*

FIFTH PRIZE—20 W. Amplifier with shield and tubes,  
ready to operate, type 32-20C, \$64.00  
*Offered by Vocagraph Sound Systems*

SIXTH PRIZE—30 W. High-Gain Amplifier, with  
tubes, ready to operate, \$62.90  
*Offered by Radolek Company*

SEVENTH PRIZE—Velocity Microphone, type RBHK,  
\$42.00  
*Offered by Amperite Company*

EIGHTH PRIZE—Baffle, type B-5, \$36.00  
*Offered by Fox Sound Equipment Corp.*

NINTH PRIZE—Airline Velotron Microphone, \$32.00  
*Offered by Montgomery Ward & Company*

TENTH PRIZE—Bruno Velotron Microphone, \$27.50  
*Offered by Allied Radio Corp.*  
*(Continued on page 41)*



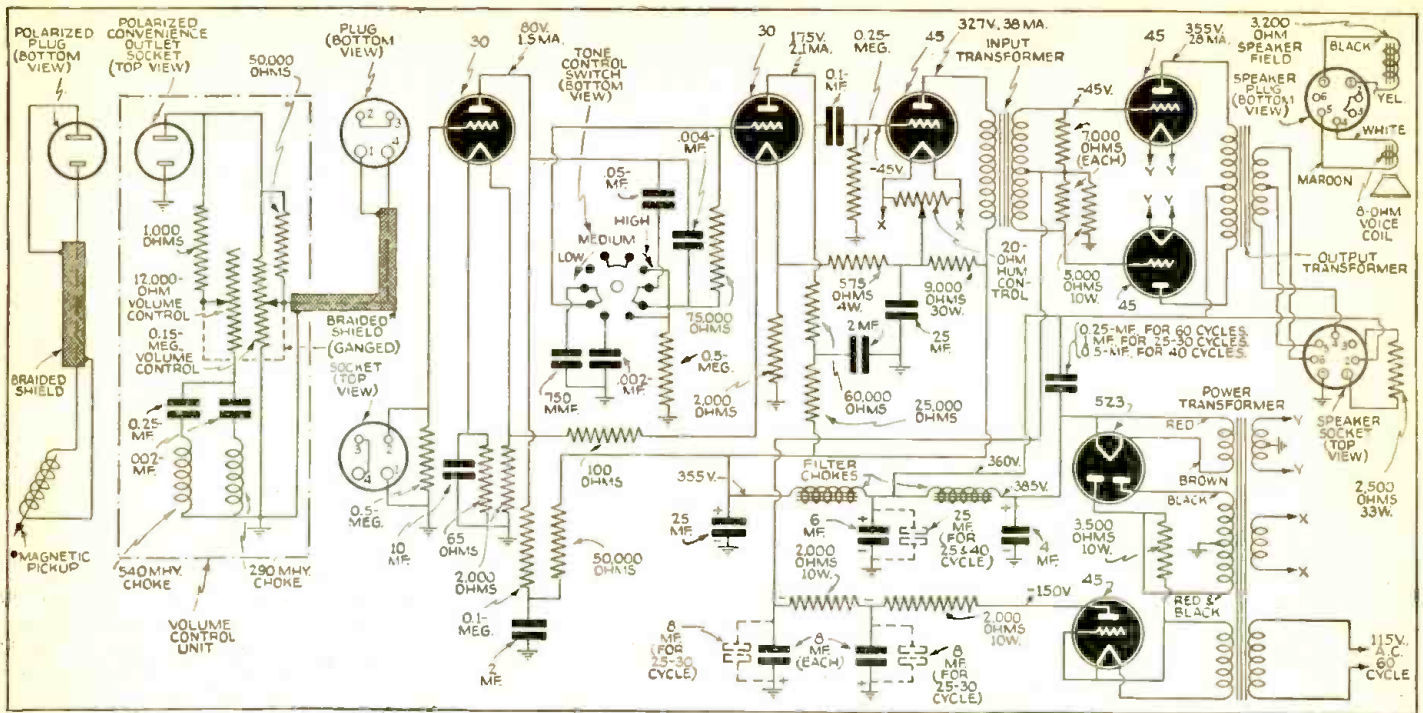

Fig. 1. Schematic diagram of the amplifier used in the Wurlitzer model 616 coin-operated electric phonograph.

## SERVICING "Coin-Operated" PHONOGRAPHS

*Servicemen will find that, on 9 out of 10 calls, it's the sound system and not the mechanical system of coin-operated electric phonographs, in the innumerable clubs, grills, halls, etc., that now utilize this form of entertainment, which requires servicing. There's business here for you.*

SANFORD MILLER

No. 2

**T**HE radio Serviceman who contemplates entering the phonograph field will find that servicing coin-operated phonographs will undoubtedly help to fill out the summer slump in radio service work.

This is due to two causes: the instruments themselves, in most locations, do a larger volume of business during warm weather; and secondly, the combination of high temperatures and high humidity that prevails during the summer months tends to cause more frequent breakdowns in the electrical portion of the machines.

Another factor the Serviceman should consider is the absence of keen competition in this field, enabling his fee for

repairs to be more in keeping with his technical ability instead of being based on cut-throat competition. As an example of how rendering quick service is more important to the average operator than the amount charged for repairs, let me mention a recent occurrence.

An out-of-order call came in on an old model Capehart Orchestrope located in a tavern 60 miles away. The operator reported that the instrument lacked volume, and he requested immediate service. Examination showed no field on speaker, caused by an inoperative Kuprox rectifier unit, which, together with a stepdown transformer, comprised the field exciter. Since the machine was about 6 years old and no replacement was available the tightening of the center bolt on the rectifier stack was tried and after about 4 complete turns were taken up on the clamping bolt, the output of the rectifier unit jumped to normal, restoring the volume level to normal. A bill for \$20 covering repairs and traveling expenses was promptly paid.

magnetic pickup, as are all subsequent Wurlitzer models, and uses 2-30's, 3-45's and a 5Z3. Common complaints on this model are as follows:

**Distortion:** Look for defective damping blocks in pickup. Check coupling condenser from plate of 2nd A.F. 30 to grid of driver 45 for leakage or short. Check input transformer for primary to secondary leakage or short. Check 1st A.F. plate coupling resistor for open.

**Low Volume:** Examine pickup for frozen armature caused by defective damper blocks. Check input transformer for partial short in primary. Normal resistance about 700 ohms. Examine tube sockets, as oil, dripping from mechanism, sometimes deposits carbon and metal particles where they may cause carbonizing of sockets.

**Hum:** Check shielded cable running from pickup to amplifier for resin joints at pickup terminal strip or amplifier input plug. Check adjustment of humbucker (located between output 45's and 5Z3).

**Fading:** Remove cover from magazine switch (located directly over cash box) and examine carbon contact and copper contacts for poor connection. Tighten if there is overheating or scorching at this point; and also tighten screw holding pigtail connection on carbon contact. These connections frequently loosen

(Continued on page 48)

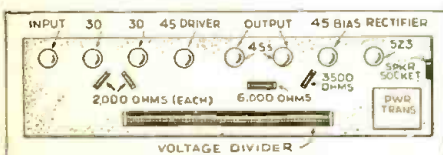

Fig. 2

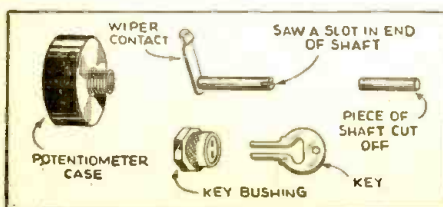

Fig. 3

### OPERATING NOTES

In connection with the operating notes which follow, discussion will center on those machines that enjoy wide distribution.

#### WURLITZER MODEL 412

This is a 12-record machine, 1936 model, equipped with an oil-damped



# Radio Service Puzzlers

The Triplett Electrical Instrument Co. recently closed its Radio Service Puzzler Contest—and here makes available in this article, special to RADIO-CRAFT, excerpts from entries in this Contest, which this month replace Operating Notes, and Service Questions and Answers.

## ODD DISTORTION CASE

### ● The Radio: Philco Model 81

There was a distortion at a particular audio frequency somewhat similar to a speaker rattle. At this frequency the output would drop and take on a very odd rattle as was shown with an output meter and an audio oscillator. After checking the audio end closely a vacuum-tube voltmeter was used when it was discovered that the trouble originated before the A.F. end was reached, by also allowing the receiver to be tuned to an incoming broadcast.

Going towards the front end with the vacuum-tube voltmeter the trouble was finally found to be in the oscillator or the primary of the input I.F. transformer, or both.

The output from the first I.F. transformer varied exactly as the A.F. output to the speaker while the signal generator showed the 1st-detector—oscillator was getting a steady signal.

After exploring with the vacuum-tube voltmeter the trouble was run down as a shorting compensating condenser (No. 13 in Gernsback 1934 manual). This condenser had been damaged previously and the mica between the plates had flaked off leaving a portion of the plates separated by air by less than a thousandth of an inch. Mechanical vibration set up by a note of a certain pitch would short these plates, or probably vibration of the support, would cause the plates to short thereby throwing not only the oscillator frequency off but also the I.F. primary tuning.

## SOLDERING IRON MAGIC

### ● The Radio: RCA Radiola 44, late model S.P.U.

Cuts out after 5 minutes to 2 hours operation. Snapping line switch or any attempt to make measurements would cause it to snap back into operation.

It was decided to use the oscillator and neon output indicator, starting at output stage with 400-cycle signal for about 3 hours with no decrease in output. A modulated signal was then fed to the detector stage with the same results. It was then fed to the 2nd R.F. stage and in about 45 minutes the neon went out. The signal was then fed to the 1st R.F. stage with about the same results.

I examined the diagram of this model and it was found the 2nd R.F. stages were biased with 2 resistors in parallel—80 and 540 ohms. The 80-ohm resistor was of the vitreous enamel type. I then decided to try an experiment. I connected the ohmmeter across the resistors (70 ohms, total). I then held a hot soldering iron near each resistor for a few minutes. After a few minutes near the 80-ohm resistor, the resistance jumped to 540 ohms! Replacing the 80-ohm resistor cleared up this trouble.

## FINGERS SOMETIMES HELP

### ● The Radio: 1938 model, 5-tube, 2-volt Zenith battery set

Complaint: the volume was about a third or a half off what it should be and the

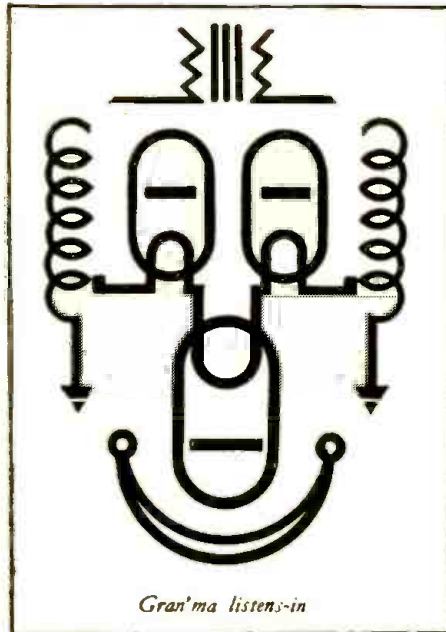

Gran'ma listens-in

Punch, London, Eng.)

... and is puzzled?

customer could not understand speech plainly.

The "A", "B", and "C" batteries were almost new and showed full voltage when checked. The tubes checked OK. I next checked all the tube socket voltages. They were all correct. The next thing I did was to set my signal generator at 900 kc. with a 400-cycle modulated note. The receiver was then tuned to 900 kc. and the 400-cycle note observed at various points with the oscilloscope.

At the voice coil of the speaker the 400-cycle image was normal at a low volume but when the volume was increased to about the average operating volume of the

In adjudicating entries in the Triplett Radio Service Puzzler Contest, selections were based on real "puzzlers" which were solved by rational technique involving both the mental process of diagnosis and proper utilization of testing equipment.

receiver, serious distortion occurred. This distortion was present at both plates of the 1J6G output tube. It was also present at both grids of the 1J6G. It was still present at the plate of the 1H4G driver but there was no distortion at the grid of the driver tube.

To check against any error in my tube tester and to take ample precaution not to waste any time unnecessarily I replaced the 1J6G output and the 1H4G driver tubes. There was no change.

Here I stopped to "take inventory" of the results I had found and to resolve it into just so many possible causes of the trouble. The problem had then begun to

become a "puzzler". I saw then that I had the following possibilities: (1) defective driver transformer, (2) defective output transformer, or (3) defective voice coil in speaker.

Since the voltage gain of the 400-cycle note was less in the output tube than it should have been, I decided to temporarily eliminate the possibility of the driver transformer. I checked the D.C. resistance of the output transformer primary and secondary. It was normal and there were no grounds. I then checked the D.C. resistance of the voice coil to see if there were any shorted turns. I also checked the correct resistance.

Then I was really puzzled as I had gone over everything carefully and in a systematic order, and had found nothing defective. I still felt that the trouble was in the output and since the output transformer was mounted on the speaker it was only a simple matter to replace the complete unit. I did this and the radio set performed normally. This definitely traced the trouble to the speaker. I again prodded the test leads from the ohmmeter directly across the voice coil of the speaker. The resistance checked normal.

I then reasoned that since the voice coil and cone are moving up and down continually during normal operation that it might be a good idea to move the cone up and down with my fingers. This seemed to be a useless idea but in such a case anything goes. I moved the cone up and down several times and watched the ohmmeter. Suddenly the hand dipped down to about one-third of its normal reading. This showed that approximately two-thirds of the voice coil was being shorted out while in motion but perfectly normal while idle.

I replaced the cone of the speaker, made out a service sheet, and called it a day.

Moral:

Always have plenty of good, dependable test equipment on hand because your next service job may be just such a puzzler and the customer will not realize that it is a tough problem but will probably decide that you are untrained, inexperienced, and above all, poorly equipped.

## TRY A VACUUM-TUBE VOLTMETER

### ● The Radio: Model 15K RCA

The complaint was a pleasant ph-zzz (don't let that word "pleasant" fool you), which emanated from the speaker when set was playing at low volume, or volume entirely off. The owner explained the radio receiver had been serviced several times, but the same pleasant ph-zzz remained. Of course, the usual question—How much will it cost?—popped up, but we cautiously evaded the issue and it was well that we did.

Finally breaking away, I rushed madly back to the shop to see what ailed the d-n thing.

Test procedure: Entirely disconnected the R.F. end of the radio set, the detector, working toward the final audio stages, substituted condensers and then with only the 6L6 outputs and rectifier connected, did we

(Continued on page 42)



# SERVICING TELEVISION

Unlike previously published articles of a theoretical nature on the servicing of Television and Short-Wave World (London, England), is a practical analysis illus-

S. WEST

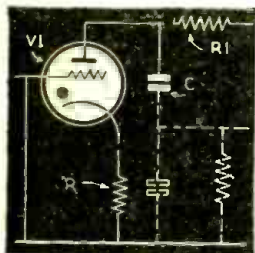

Fig. 1

LAST month the requirements for linearity of scan in the time base were dealt with. It was shown that with adequate high-voltage for the time base, it is a simple matter to adjust the negative bias for the discharge device to such a value that linearity is ensured and, at the same time, retaining adequate amplitude of the sawtooth wave so that a full sweep across the screen is secured.

It was also pointed out that, as the bias is reduced to a value where linearity is achieved, the frequency of the oscillation is correspondingly increased and it is necessary to restore to the correct frequency by increasing in value the charge resistance. It was assumed that the charge condenser has a value conforming to convention for the frequency of

oscillation desired. This requirement usually is satisfied in an original design but, to ensure sufficient knowledge is imparted herein to permit a change in the value of this constant, should such prove necessary, the diagram of a representative scan-frequency sawtooth oscillator, Fig. 1, is given.

In this diagram, V is a gas relay, R1 and C the charge resistance and charge condenser respectively. Unit C usually is comprised of 2 condensers but for simplicity is depicted as a single condenser.

First, let us assume that by reducing the value for R (reducing the -ve bias) to a value where linearity is achieved, we have increased the frequency of oscillation considerably and let it be further assumed that it proves impossible to restore to the correct frequency by increasing the value of R1. Then the value for C must be increased. Similarly, if to increase the amplitude of sweep, we have increased R and thereby reduced to operating frequency, we may find it impossible to restore to correctness by reducing R1. Then the value for C must be reduced.

It is emphasized that if a design has been followed, it is unlikely that such changes in the constants will be required and such alterations should only be undertaken where exhaustive tests reveal the impossibility of securing good performances with normal manipulative changes to the variable constants included in the design.

Also the importance of C being comprised of 2 condensers must not be overlooked, for a haphazard change in value to only one of these can affect both the linearity and amplitude of sweep as is apparent when the combined capacities are regarded as a form of *capacity potential divider*.

## TIME BASE TROUBLES

Now while on the subject of incorrect time base operating frequencies let us consider some of the more usual troubles experienced in this direction.

Figure 2 depicts the effect obtained when the line (horizontal scan) time base is operating at too low a frequency, actually when the frequency of the line base is half the correct one. The remedy has already been outlined, namely, to reduce the value of the charge resistance (R1), or, to cause the discharge tube to operate earlier in the cycle with a reduction of bias (reduce R).

Figure 3 again depicts a fault in the line base, in this case, however, the operating frequency is too high, actually twice the correct one. Readjustment of the same controls will effect a cure; e.g., increase the value of the charge resistance (R1) or, increase the value of -ve bias for the discharge valve by increasing in value the cathode resistance R.

It is possible readily to differentiate between the 2 effects. It will be seen that with the time base operating at a too low frequency, 2 or more entirely separate images are produced (integral sub-multiples of the correct frequency will produce a corresponding number of complete images horizontally displaced), whereas, when the frequency is higher than is correct 2 or more images result, but each will overlap and characteristic bright vertical bands will appear.

Figure 4 shows the effect with the frame base (vertical scan) operating at one-half the correct frequency; that is the frequency is too low, whereas in Fig. 5 the frame base frequency is too high. These 2 faults are corrected in an identical manner to that described for the line time base, the procedure outlined being now applied to the discharge tube of the vertical scan generator. Again note that the characteristic appearance of these faulty images enables the fault to be correctly diagnosed, though a more readily apparent



Fig. 2. Effect due to line time base operating at  $\frac{1}{2}$  correct frequency.



Fig. 3. Effect due to line time base operating at twice the correct frequency.



# RECEIVER FAULTS

vision receivers this series of articles, which we reprint by special permission of *trated with photographs of images which depict the actual faults being discussed.*

## PART II



Fig. 4. Frame time base operating at  $\frac{1}{2}$  the correct frequency.

effect, not revealed in the photograph, renders the diagnosing of the fault of Fig. 4 (frame base operating at half correct frequency) very simple. Due to the low image repetition frequency, 25 per second, a pronounced flicker is a characteristic of the fault.

Finally, in this collection of multiple images attributable to incorrect scan frequencies, we have the generous phenomenon of 4 images instead of 1 (Fig. 6). This effect is obtained when both the line and frame bases are operating at one-half the correct frequencies. To remedy, the procedure already outlined is applied to *both* time bases.

The foregoing completes the description of faults directly attributable to the sawtooth generators but, before leaving the time base as a whole, it is necessary to consider the sections concerned with amplifying these sawtooth oscillations.

### SWEEP VOLTAGE

A quite high amplitude of sweep voltage is required if the deflection of the light spot is to provide the maximum size of image accommodatable by an average C.-R. tube (7 in. to 12 in.) and it is necessary to amplify the sawtooth wave provided by the discharge tube. Furthermore, in the case of electrostatic tubes it is very desirable to provide a balanced amplifying system to feed the deflector plates. The need for this is apparent, upon consideration, for otherwise the final anode, to which the deflecting plates must be tied, will have a varying potential and this will manifest itself in 2 ways. (It should be mentioned that the above is not, truly speaking, an accurate description of what happens but it is simpler to understand in this manner.)

(1) The deflection sensitivity of the tube, which bears a definite relationship to the final anode potential, will vary in sympathy with an unbalanced scan voltage. This is responsible for the effect known as "trapezium" distortion. See Figs. 7 and 8.



Fig. 5. Frame time base operating at twice the correct frequency causes the image to overlap.

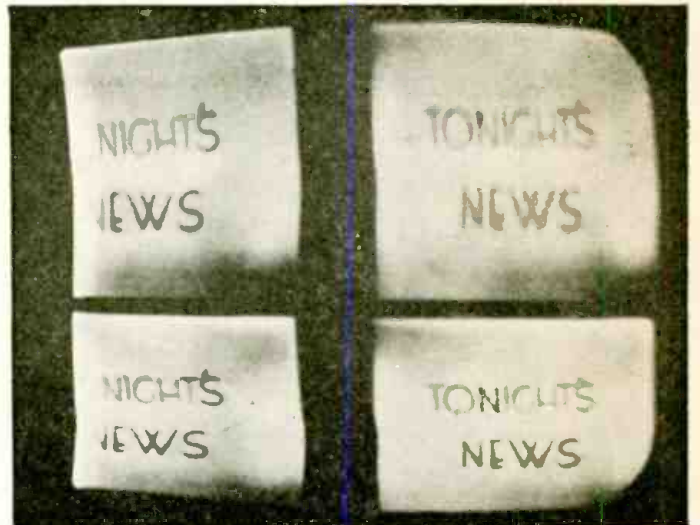

Fig. 6. Here both line frame time bases are operating at  $\frac{1}{2}$  the correct frequency.

(2) The light spot focus which is a function of the ratio in potential between the second and final anode will vary, resulting in loss of focus and thus definition for some part of the picture. A balanced output system largely combats these defects and for this reason such a system is generally employed. Figure 9 gives the circuit arrangement usually adopted. For simplicity, it is depicted shorn of non-essentials, for we are here concerned only with ensuring that a balanced or "paraphase" output is secured.

It will be apparent from a study of this diagram that the output of V2 is of opposite sign to that of V1 for a reversal in phase of the signal is effected by V2. We have thus only to ensure that the output from this tube is substantially equal to that of V1 and a balanced deflection is obtained.

In the following, it is assumed the values assigned the coupling condenser C and a grid leak R3 permit the effect of these components to be ignored and, to ensure balance, we

(Continued on page 61)



# CIRCUIT OF COMMERCIAL TELECEIVER

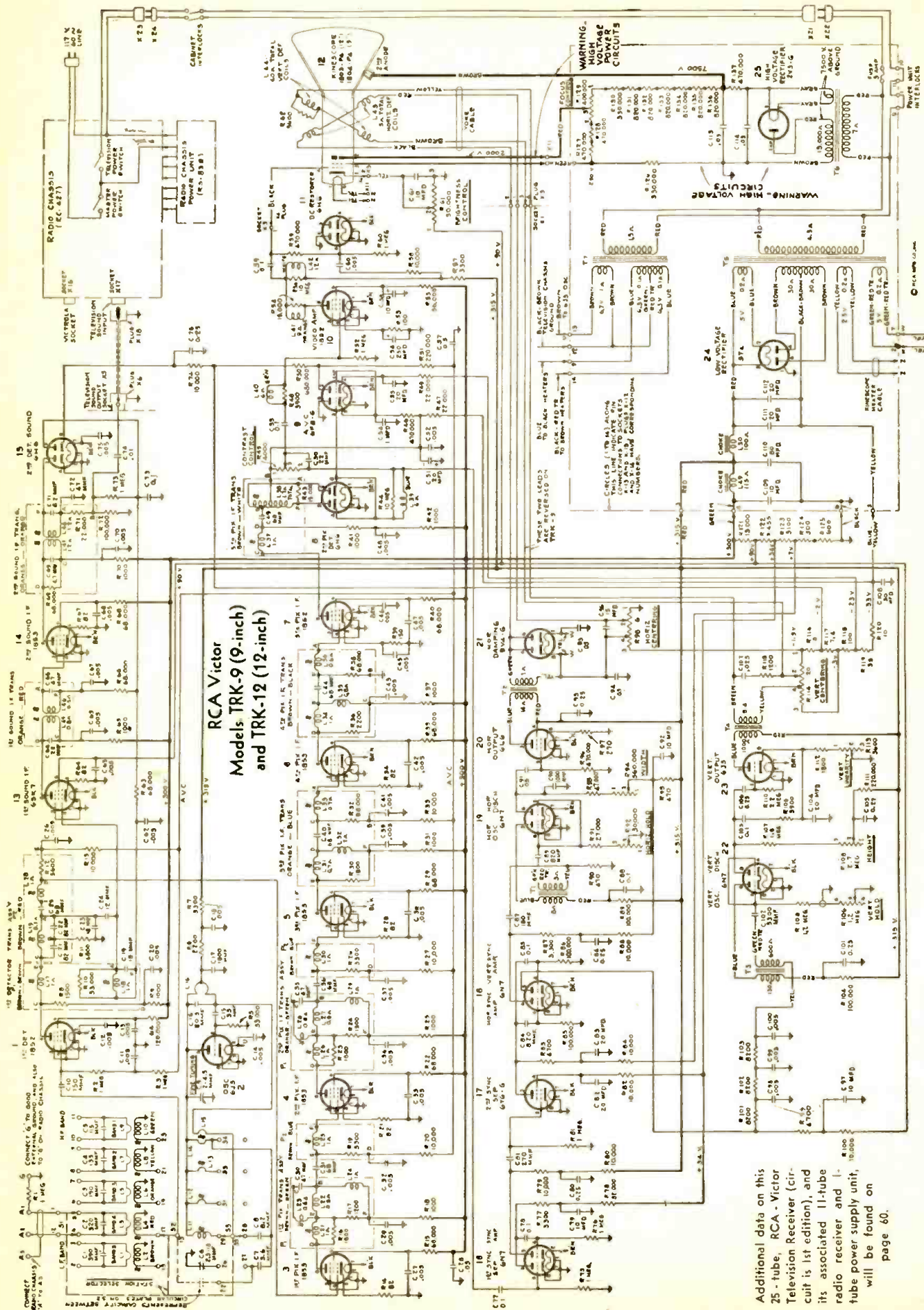

RCA Victor  
Models TRK-9 (9-inch)  
and TRK-12 (12-inch)

Additional data on this 25-tube, RCA-Victor Television Receiver (circuit is 1st edition), and its associated 12-inch radio receiver and 1-tube power supply unit, will be found on page 60.



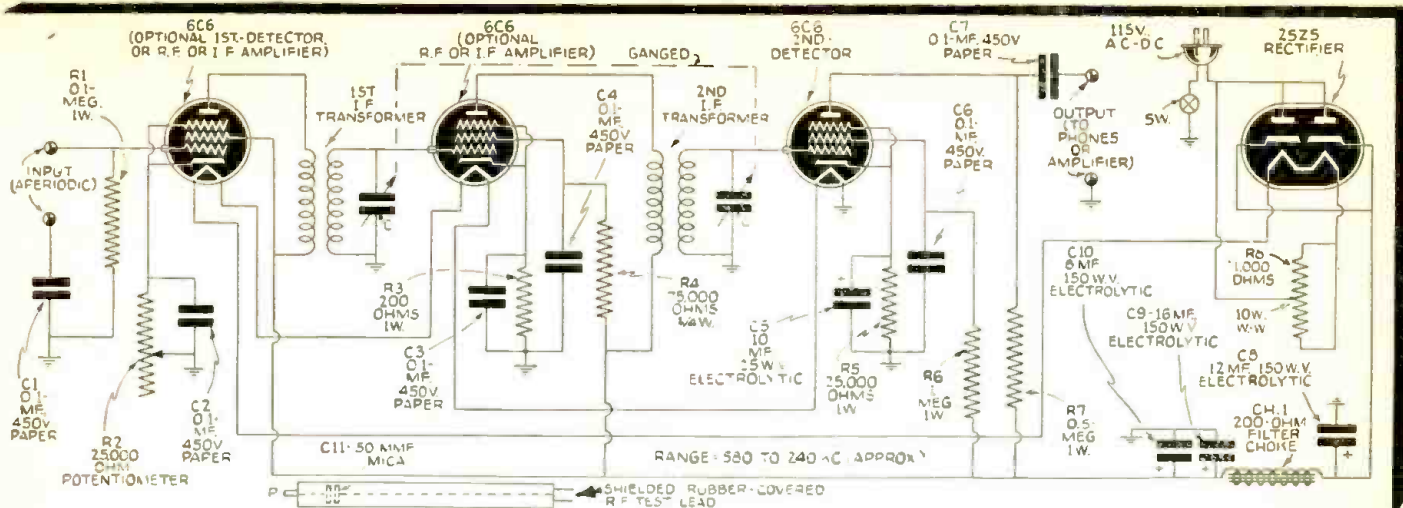

The author's I.F. Tuner used "junk-box" parts. Exceptions, though, were the tubes; the 10-W, center-tapped and wire-wound resistor; and, the I.F. coils, which were 456 kc. "replacements."

## AN I.F. TUNER FOR SERVICEMEN

*A Serviceman (and former Chief Radioman, U. S. Coast Guard), tells you how to make and how to use a special Intermediate-Frequency Tuner for shooting trouble, quicker and better, in superhet.-type receivers.*

GEORGE A. WALL

**I**N THE Radio Repairing business the important procedure is to localize the trouble in as small an area as possible and in the shortest possible time. Having localized our trouble it is a simple matter to apply the fundamental tests—continuity, voltage, and resistance measurements—to all the components concerned.

### "FINGER TEST"

The "finger test" is probably the simplest method used by the experienced Serviceman. If it fails to produce a click in the loudspeaker, experience points to probable breakdown in the high-voltage supply somewhere along the line. The trouble is usually located by lack of voltage on some tube plate or filter connection. This method is fundamental and one could hardly wish for a quicker or better method. At least 70% of the troubles encountered during the day, outside of bad tubes, will be located in this way. This is to be expected since components carrying the higher voltages are more susceptible to breakdown.

However, the finger tests work best in the audio end. Tapping or opening the grid of an I.F. or R.F. tube may or may not give us a hint as to where the trouble lies, especially if the 2nd-detector or oscillator stage is not working properly. The 2nd-detector especially may give rise to tricky troubles particularly if the tube tester on hand does not test diodes or expensive apparatus is not available. Should the trouble lie in the diode circuits much head scratching and thumbing of diagrams may result, and also a good workout in shifting leads to different meter setups.

### 2ND-DETECTOR INPUT AND OUTPUT

With everything working but the 2nd-detector the chain is broken and the audio end is useless as an aid to finger testing. However there is an I.F. signal being fed into the 2nd-detector going to waste. It can be picked up by an *intermediate frequency tuner*, then fed into an audio frequency amplifier and a good rectified signal received through a test speaker. The construction of such an I.F. Tuner will be described after we have shown how useful it is.

A check can be made of the I.F. signal quality and everything ahead of the 2nd-detector can be forgotten, resulting in a definite feeling of relief that that large portion of the circuit is eliminated as the source of trouble.

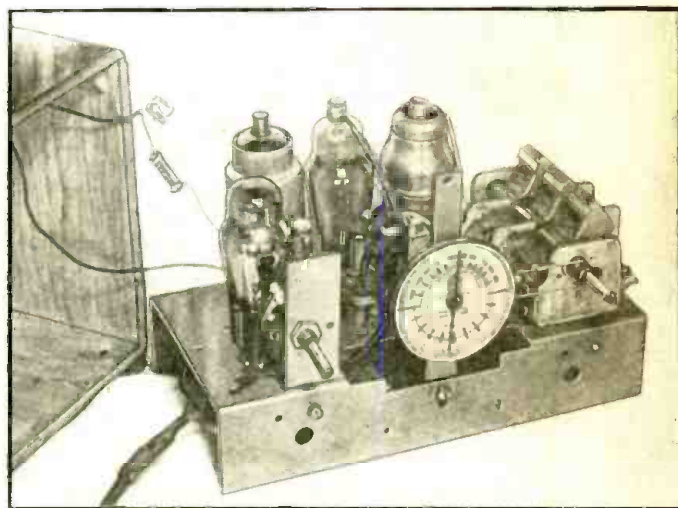

The variable condenser gang tunes not only I.F. but also R.F. circuits, now.

Next a check can be made of the 2nd-detector output to be sure it is not functioning. This is done by connecting the input of the test audio amplifier to the set's 2nd-detector output. If no signal results the trouble is definitely shown to be in the 2nd-detector. This test can, of course, be made with a test oscillator provided both an audio and R.F. signal are available. However, its resulting note does not give the assurance that results from a test of the broadcast station signal. In addition, the output of the Tuner may also be fed into the audio end to check further, if desired. This is done by attaching an aerial to the Tuner's input and tuning its high-frequency end to a broadcast signal.

### THE MIXER

Trouble in the oscillator alone usually is not hard to localize, although to effect a repair is sometimes more difficult. Tapping the aerial post results in a good click in the loudspeaker. This hint is immediately followed by a new oscillator tube or a check-up at the oscillator tube prongs. No use to clutter up the work bench with test leads when

*(Continued on page 52)*





"RADIO IN EVERY ROOM!" Any one of 4 programs may be selected by merely turning a switch. In addition, a talk-back system between any 2 speakers is obtained by throwing another switch. These photographs show the installations in dining room, bedroom, and kitchen (left to right).

*Another Home With Built-In Radio!*

## 4-STATION RADIO SYSTEM

*Following the logical trend of building radio into homes at the time of their construction, system which, as an added feature, may be instantly converted into a talk-back system—*



**R**ECENTLY, much has been heard about remote-controlled radio receivers. There are many excellent receivers available and many thousands are sold each year. In every case however, only one station or program at a time is available. Thus if father wishes to hear Amos 'n' Andy while mother wants to listen to a fashion show

and little Jimmie wishes to hear the baseball scores, there is usually an argument the outcome of which is that father and Little Jimmie also listen to the fashion show whether they want to or not.

Of course, and as the senior author of this article clearly pointed-out in his previous instalments in the article "This Home—Wired for Radio!" (especially, as noted on pg. 718, in the preceding, June 1939, issue), there are arguments in favor of both systems. It is up to the individual home-owner to decide which system best meets his requirements. Details for installations of both types, with the presentation of this article on a "Radio Home" installation of the second character, are now available for his consideration.

### MULTI-CHANNEL OPERATION

The wide acceptance of pushbutton-tuned receivers, on the other hand, definitely proves that the majority of listeners have 3 or 4 favorite radio stations to which they listen about 90% of the time.

Most of the larger hotels have *centralized radio systems*, and have been wired for either 3 or 4 "channels" or program lines. Many of these hotels often find it difficult to furnish the 4th program on the basis of a quality program as compared with the other 3. This is especially true where the hotel is located in one of the smaller cities and has only 1, 2 or perhaps 3 local stations with network programs to pick from and therefore must resort to an out-of-town station for the 4th program. Thus 4 stations are more than ample for this class of service.

Wired systems have proven to be very reliable as evidenced

by the low maintenance cost,

**N. H. LESSEM and**

in conjunction with continued and consistent service from one end of the year to the next, that has been obtained by hundreds of hotels all over the United States that have such internally-wired radio systems. Most of these systems employ wiring which was not built-in but which was installed—"fished" through walls, etc.—after the structure was built.

In the past, such systems were only practical for large buildings—hotels, hospitals, etc.—inasmuch as the cost was quite high and the equipment for this purpose was not available for general use. This year, however, a special cable adaptable for such work was placed on the market. Also a new type of relay was developed that allows simultaneous operation of both the on and off positions of any equipment by merely pushing the same button for both operations.

The system to be described is based on the same principles that are used in centralized radio installations but has been developed for small homes. It can, however, be used in any home *regardless of the size or number of rooms.*

### ADVANTAGES

Perhaps the best advantage of the system is that 4 programs are available in any room and that any one of these 4 stations can be heard separately in each room at the same time if so desired. The room equipment is designed for flush mounting, with the speaker panel flush to the plastered wall. There is also available, however, an offset surface-mounted cabinet type unit that can be fastened directly to any wall.

Since only local reception is required, the tuners should preferably be tuned radio frequency units. The units used in this article, however, were 2-band superhets., the circuits being quite standard. The output is fed through a matching transformer in order to match the combination of speakers. These tuners are usually placed in the cellar but may be installed anywhere that is convenient, such as the attic, a closet, etc.

The antenna is then fed through to the tuners. In order to avoid noise pick-up a transposed, or twisted, pair of wires is used and connects with a special multiple antenna system. The antenna itself is a 100-foot "L" whose output feeds a





Each wall panel is easily installed and easily serviced. Here we see a rear view of a wall unit showing all components compactly and conveniently mounted on a single panel. At right is the array of 4 broadcast receivers located in an ordinary home-built box situated in the cellar of the home. Each set has its own speaker (used only for tuning-in and pre-setting of stations) and its individual master switch. (All photos—Talbran)

## —Plus TALK-BACK FEATURE

RADIO-CRAFT is pleased to present this interesting description of a 4-program radio yet the entire installation (Servicemen take note) may be made for about \$250!

**ELI M. LURIE** coupling unit which in turn is connected through the twisted-pair transmission line directly to the tuners. Here the multiple antenna set couplers prevent interaction between the I.F. oscillators of the Tuners. If such couplers are not used then it will be necessary to use separate antennas or have at least two stages of R.F. in the super-het.

### TALK-BACK

As explained elsewhere, this system makes use of 4 channels or 4 separate stations (or programs). Now in conjunction with the 4th channel an amplifier is used for talk-back. By merely throwing a simple switch the radio section of the 4th channel is cut out and the talk-back amplifier is automatically connected in its place, into the 4th channel. On each speaker panel, a small switch is provided for instant 2-way communication between any room, any combination of rooms or any number of rooms. As an example, with the talk-back connected, one room-speaker may be used to pick up any sound that may occur in any other room or for that matter in any other rooms or group of rooms. It is not limited to any single room. Also, a small speaker unit may be installed at the front and rear doors of the home and these units may be used to answer any callers without going directly to the door. Thus mother could be in any part of the house and know instantly when baby awoke or began to cry. A sick or bedridden person would only have to call once, and yet, regardless of which room his nurse were in, the trusty loud-

speaker would advise the nurse that the patient was in need of attention.

### INSTALLATION

The installation of the equipment is simplicity itself. The special cable that

has been designed for this purpose is known under its trade name as "AMER-CODE CABLE" and is very economical. Although the system is sold as a complete assembly, this special cable may (Continued on page 49)

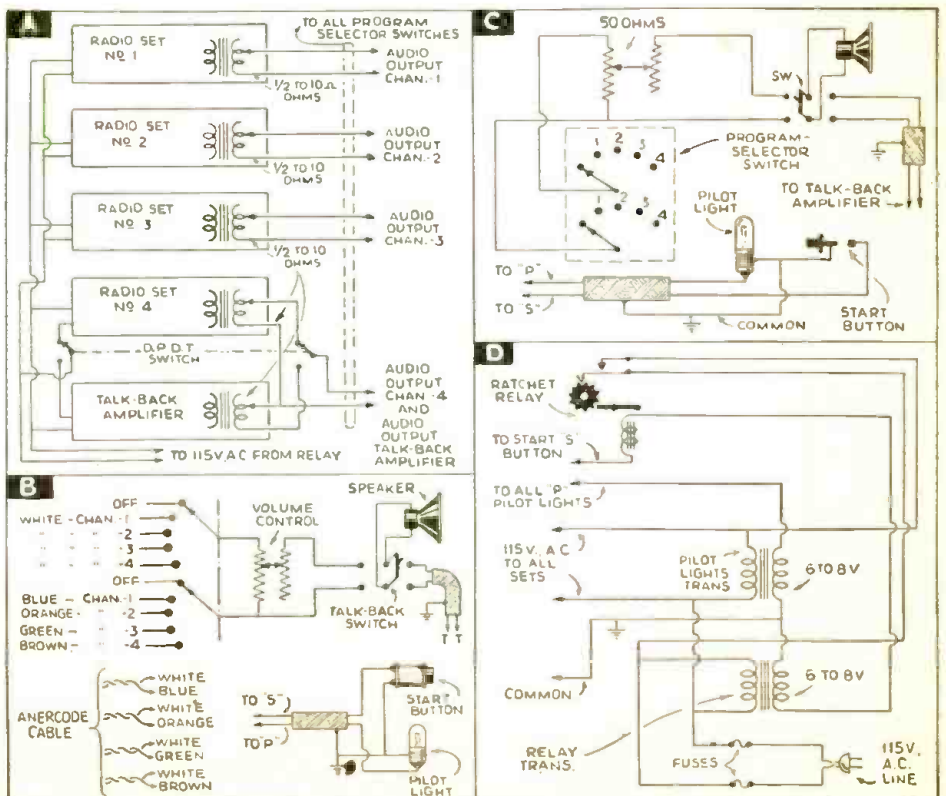

Diagrams of the complete installation. (A) shows how the A.C. line and set-output connections are made; (B) the wiring to the selector switch on the room units as well as the color code of the cable; (C) the wiring of a complete room unit; and (D) the wiring of the relay transformer, relay, and pilot light transformer.



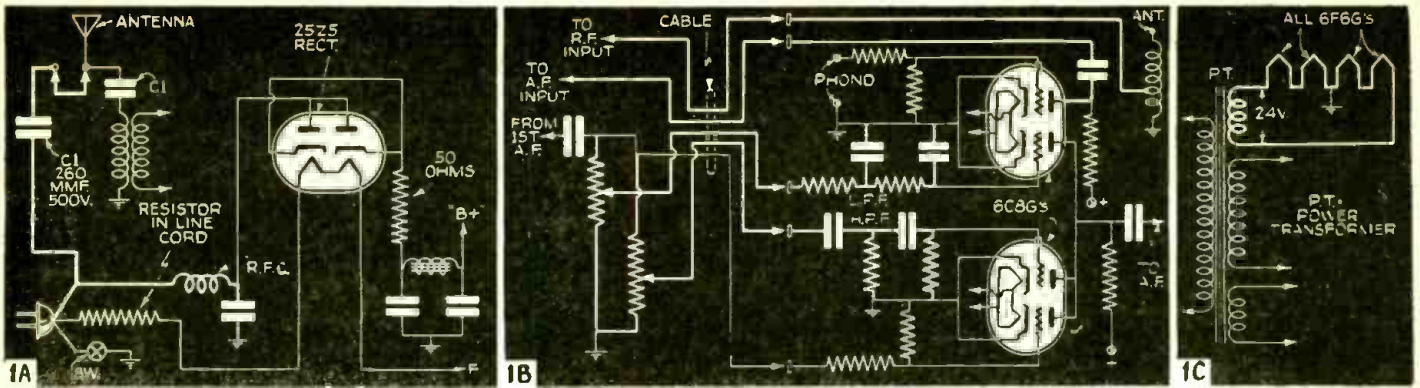

Fig. 1. New circuit features of (A) Stewart-Warner Chassis Models 07-51, 07-51S; (B) Pacent High-Fidelity Receiver; (C) Montgomery Ward Model 62-403.

# NEW CIRCUITS IN MODERN RADIO RECEIVERS



The details of the modern radio receiver circuits that make them "different" from previous designs are illustrated and described each month by a well-known technician.

F. L. SPRAYBERRY NUMBER 22

**(1) OPTIONAL USE OF POWER LINE FOR ANTENNA**

Stewart-Warner Chassis Models 07-51 and 07-51S. A plug-in link connects the antenna binding post of this receiver through a condenser to the power line terminal which is not connected to the receiver chassis, to serve as an antenna when an external antenna connection is not desired.

The condenser C1, which is a 260-mmf., 500-volt mica unit, is connected as in Fig. 1A. A radio-frequency choke, R.F.C., serves to prevent the R.F. signal on the power line from being shorted by the low resistance of the rectifier, and low impedance of the power supply filter. Any Serviceman who is familiar with the temporary installation method of connecting the antenna post of a receiver to a suitable ground will realize that for the average installation this will serve as a satisfactory antenna. As an expedient when the use of an outside antenna is impracticable or impossible this method will be found quite satisfactory.

**(2) NEW HIGH-FIDELITY RECEIVER HAS A.F. BAND MIXER (AMONG OTHER THINGS)**

Pacent (Experimental Model). Individual adjustment of various sections of the complete A.F. band is made possible with this new circuit.

From Fig. 1B, we see 4 input circuits, one of which is the phonograph input. Of the other 3, one is a normal input, one has a low-pass filter in the grid circuit, and the 3rd a high-pass filter in the grid circuit. The R.F. input consisting of a T.R.F. tuner is remotely located, and is cable connected to the audio amplifier. The cable carries an antenna transmission line (as the antenna is connected at the output amplifier location as the diagram Fig. 1B shows), the amplified phonograph pickup signal, the outgoing signal from the detector of the tuner, and the tuner filament supply. The entire circuit is of most unusual design.

**(3) POWER TUBE FILAMENTS OPERATED IN SERIES**

Montgomery Ward Model 62-403. From a 24-volt winding on the power

transformer 4 filaments are operated in series with their center point grounded.

As will be seen in Fig. 1C, the filaments of all of the 6F6G tubes are operated in series. This receiver has a total of 12 tubes, making a single winding for all filaments impracticable because of the inefficiency and losses in the transformer and wiring. Consequently a separate winding is highly desirable for the 4 power tubes. By wiring them in series, the I<sup>2</sup>R loss is considerably reduced in the transformer and wiring.

**(4) USE OF THE NEW 12B8GT TUBE, INCLUDING REGENERATION**

Emerson Model CF-225. In a small T.R.F. receiver the triode-pentode 12B8GT tube is used as an antenna-bias-controlled R.F. amplifier for the pentode section and a grid leak-condenser detector with regeneration for the triode section.

In Fig. 2A we have the input circuit of this receiver. A small condenser (220 mmf.) from the plate of the triode section connects to a coil section coupled (Continued on page 40)

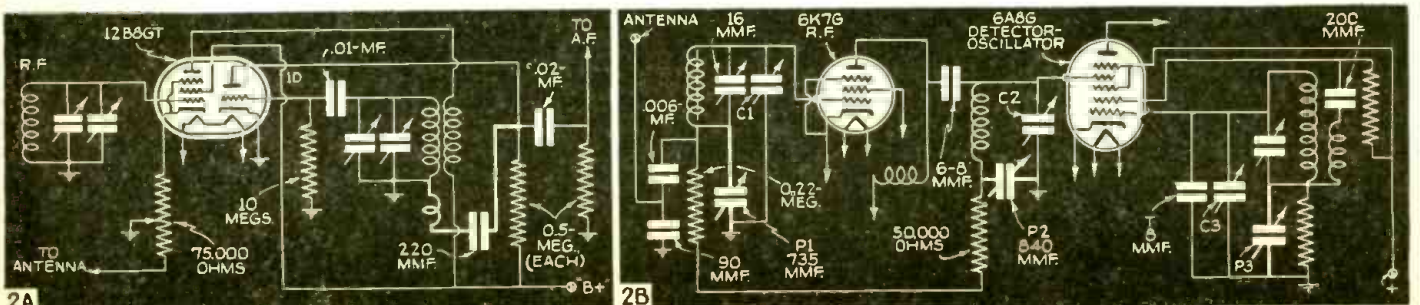

Fig. 2. New circuit features of (A) Emerson Model CF-225; (B) Motorola Model 8-70.



# USEFUL KINKS AND CIRCUITS

Contributions to this new department are paid-for at space rates; what previously-unpublished ideas to help fellow Servicemen, experimenters, etc., do you want to submit? A short description and pencil sketch will do.

## INEXPENSIVE VOLTAGE DOUBLER CIRCUIT

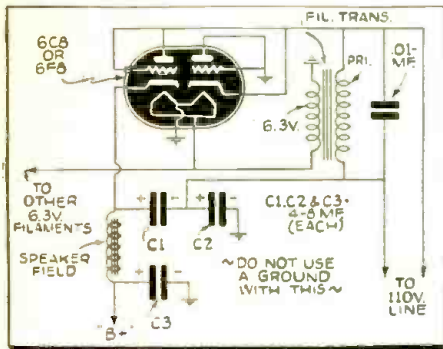

● HEREWITH is the circuit of a cheap voltage doubler circuit, for 4- or 5-tube sets, that I have been using for some time and which has proved very satisfactory.

By eliminating the filament transformer, and substituting for same a resistance power cord, this same power supply may be used on A.C. and D.C.

Do not use ground connection.

BERT CARROLL,  
San Francisco, Calif.

## "BODY-CAPACITY" ALARM

● FOR persons in fear of kidnapers, as well as for those whose frequent use of expensive jewels causes them to keep such articles about the house, there was an interesting exhibit at the American Association for the Advancement of Science. The Radio Corporation of

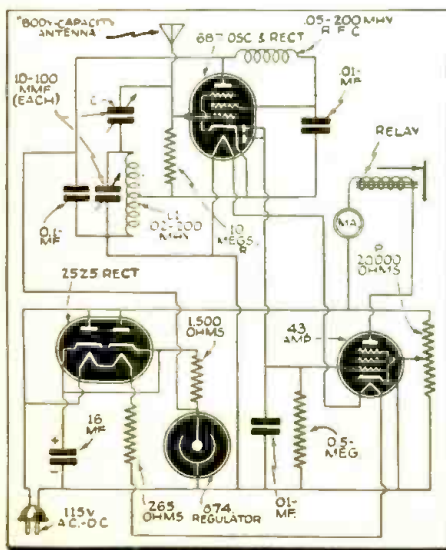

America laboratories demonstrated a simple little device consisting of a couple of tubes and a few other electrical parts that will surround any desired area with a protective screen of radio waves. When a person steps with-

in the electrical cordon, the device trips. Then bells ring, clubs fall, or anything else that can be accomplished by the closing of an electric circuit—which is plenty—can be made to happen. The device can be applied to a home safe, a baby's crib, a bureau drawer, a clothes closet, or anything else that it is desired to surround with such invisible protection.

Its application to the service of storekeepers is of equal interest. If a shop-owner does not wish to waste electric current on the illumination of his windows after closing, and yet desires to capture the interest of the passer-by at any hour, the device promises to do the trick. Simply set it at lock-up time, and thereafter through the night the electrical capacity of any human body passing close to the store windows will cause it to turn on the lights and keep them on for as long as the person might linger to gaze.

The device is simpler than the smallest radio receiver and it is estimated that it would cost no more to make.

F. H. SHEPARD, JR.,  
Atlantic City, N. J.

## INEXPENSIVE, NOVEL TUNING INDICATOR

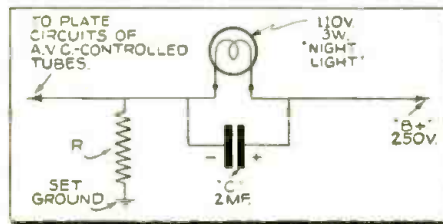

● AN inexpensive tuning indicator can be made from a filament-type 3-W. night lamp having a candelabra base and a resistor and condenser.

The lamp is mounted with the proper socket behind the dial in place of the regular pilot light and dims when a station is tuned-in on the set.

As the diagram indicates the circuit is simple and parts take very little room in the radio chassis. Condenser C is a 2-mf., 200-V. electrolytic and is used to bypass the noise caused by the filament of the lamp vibrating. Resistor R is a 2-W. type and its resistance is determined by the amount of current the A.V.C.-controlled tubes draw.

In the original circuit the tubes draw about 13 milliamperes. Resistor R is a 25,000-ohm unit drawing 10 ma. at 250 V., making a total of 23 ma. through the lamp with no signal received.

A strong station signal reduces the current through the tube circuit considerably but resistor R causes a mini-

mum of 10 ma. to flow through the lamp.

JOSEPH HARRISON,  
Fairhaven, Mass.

## HOME-MADE "RADIO" TOOL

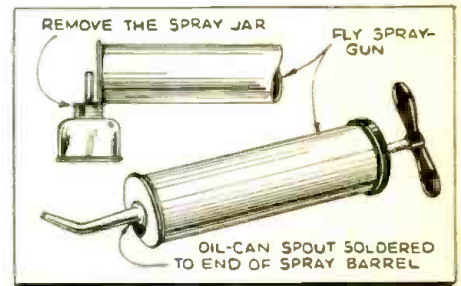

● I WAS in need of a blower the other day to blow dust out of a radio chassis and no blower was handy so I changed a fly sprayer into a blower. It works better than any I have used.

ALBERT CAMPBELL,  
Palmyra, Mo.

## NEW USE FOR OLD PART

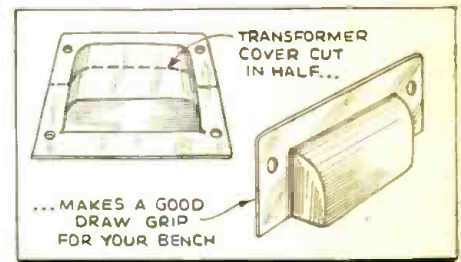

● TAKE a transformer plate that is shell or half-shell mounting, cut it in half and drill 2 holes in the corners or in each corner. This can be used for a handle of a desk drawer in your radio shop.

E. MCKENZIE,  
Ottawa, Ont.

## SIMPLE IDEA SAVES TIME

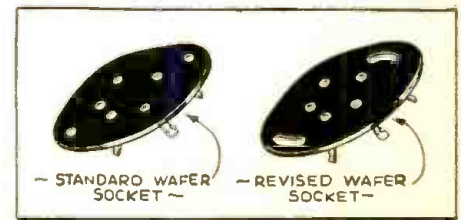

● AFTER years of replacing tube sockets in sets and trying to make them fit the holes that were in the chassis (every Serviceman knows what a job that is) I have hit upon an idea that is very simple.

As the diagram shows, the slots for the screws are so arranged that by

(Continued on page 42)







PILOT SERIES H-11 4-TUBE BATTERY PORTABLE

Superhet Circuit; Low-Drain I.4-V. Tubes; Self-Contained Loop Antenna; Permeability-Tuned I.F. Transformers; P.M. Dynamic Speaker; A.V.C.; Range, 535 to 1,600 kc.; Class A Output.

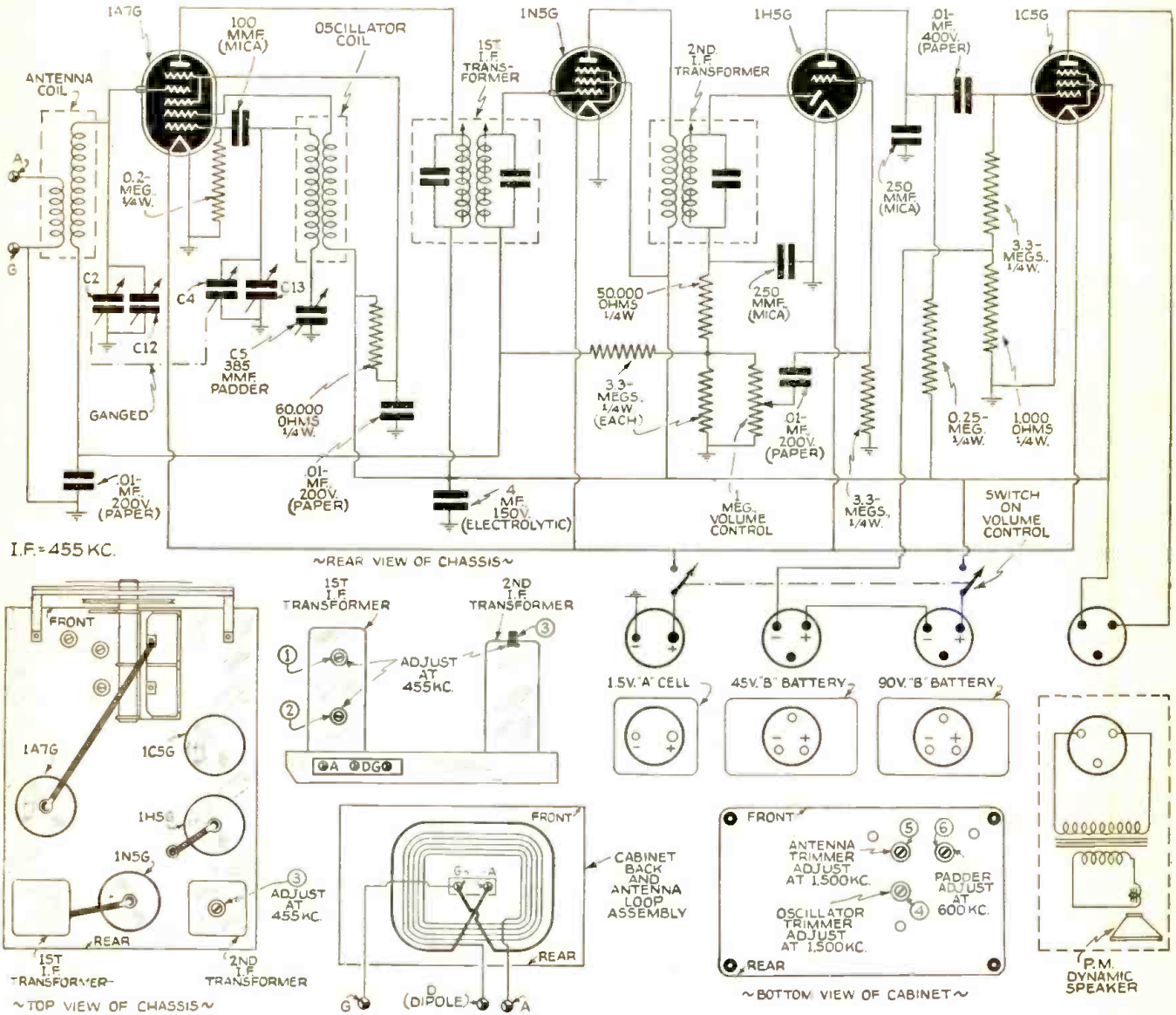

Schematic diagram and locations of tubes and trimmers of the Pilot series H-11 battery-portable receiver.

I.F. ALIGNMENT CONNECTIONS

Connect the "hot" post of the signal generator through the 0.1-mf. condenser, to the grid of the 1A7G 1st-detector.

Connect the output meter, through 0.1-mf. condensers, to the plate and screen-grid terminals of the 1C5G output tube.

I.F. AMPLIFIER ALIGNMENT

Turn the volume control to maximum volume. Set the gang condenser of the receiver at maximum capacity and make the connections noted above.

Proceed with the alignment as follows:

(1) Adjust the generator frequency to 455 kc., and set the generator output to the lowest value which will give a readable deflection on the output meter.

(2) Adjust screws 1, 2, and 3 (see figure), for maximum reading of the output meter. Keep reducing the output from the generator if the output meter reading increases too much.

If the output of the generator is too high, the alignment of the receiver will not be correct, as the A.V.C. action will become too great, and the amplifier will appear broad in tuning.

R.F. ALIGNMENT

Alignment of the receiver oscillator and antenna circuits must be done with the receiver in the cabinet, and with the chassis, batteries and loop, all in their correct location in the cabinet.

No direct connection is needed between the receiver and the signal generator to align this receiver at radio frequencies. Locate the receiver a foot or two from the generator; it may, however, be necessary to attach a short wire to the "hot" output terminal of the signal generator.

First remove the cork plugs in the bottom of the cabinet. Set the generator frequency to 1,500 kc. and turn the receiver pointer to the same frequency. Then adjust the trimmer, reached through hole No. 4 in the bottom of the cabinet, for maximum output of the receiver; and then, the trimmer reached through hole No. 5. While these adjustments are being made, do not remove the receiver dial pointer from 1,500 kc. Next, adjust the generator to 600 kc., and with the receiver set to the same frequency, adjust the trimmer through hole No. 6 for maximum receiver output while "rocking" the receiver tuning knob. Then go back and repeat the 1,500 kc. adjustments. Finally, replace the corks in their holes.



Pilot model H-11 battery portable. The set has a built-in loop antenna and self-contained "A" and "B" batteries.



# THE LATEST RADIO EQUIPMENT

The address of any mentioned manufacturer will be sent on receipt of a self-addressed, stamped envelope. Mention of item number hastens reply.



Latest "Filmgraph" recorder. (1756)

## LATEST "FILMGRAPH" RECORDER (1756)

(Miles Reproducer Co., Inc.)

THIS latest model BB sound-on-film recorder will cut 28 sound tracks across the width of 16-millimeter film. Its 500-ohm-impedance magnetic recording head is used, with a sapphire stylus, for both cutting and playback. No processing of the film is required.

The machine accommodates all sizes of reels up to 2,000 ft. of film. Drive is sprocketless, assuring flutterless operation although it will record on film both with and without sprocket holes. High-quality reproduction of all frequencies from 50 to 6,000 cycles per second is claimed for the instrument.

Each sound track will run for a period of 4 minutes for a 100-ft. length of film. Hence 28 tracks indented across the width of a 16-millimeter film will run for 112 minutes. Re-rolling of film is not required and playback may be had immediately after recording is completed. Sufficient room is allowed in the case of the instrument for amplifier, speaker, mike and reels.

permits mounting the units under the chassis with above-chassis tuning.

## A UNIVERSAL RESISTOR-LINE CORD (1758)

(Micamold Radio Corp.)

KNOWN as the "Unicord" this A.C.-D.C. line cord can be used as a replacement for burned-out line cords of practically all resistance values. The new cord is of conventional appearance except that there are 3 extra color-coded leads which are taps from the resistor element. By connecting together various combinations of these color-coded leads many different resistance values can be obtained, ranging from 22 to 330 ohms.

## ELECTRONIC SWITCH AND SQUARE-WAVE GENERATOR (1759)

(Allen B. Du Mont Labs., Inc.)

NO MOVING or vibrating parts is the feature of this combination electronic switch and square-wave generator.

The "switch" permits simultaneous observation of 2 separate phenomena on the cathode-ray oscilloscope. This is done by alternately switching 2 circuits to be observed to the input of the scope. Switching is accomplished electronically at rates of speed beyond the capability of the human eye to detect so that the 2 phenomena appear to be present at the same time. Thus the electronic switch offers a means of observing not only the amplitude and form of 2 waves but also their phase relationship. The switching rate is approximately 6 to 2,000 times per second, permitting observations of either extremely low or high frequencies.

The instrument also may be used as a square-wave generator between the frequencies of 60 to 400 cycles per second. The square-wave produced, it is claimed, is sufficiently perfect to be of considerable value in the laboratory, particularly as a means of checking amplifiers.

(Continued on page 56)

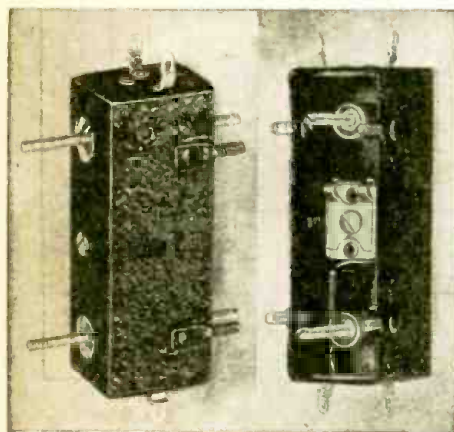

I.F. transformer for television. (1757)

## I.F. TRANSFORMER FOR TELEVISION (1757)

(The F. W. Sickles Company)

A NEW line of I.F. transformers designed especially for television sound and image channels, is announced by this manufacturer. These transformers are of the perm-trimmed type, thereby permitting maximum gain per unit with desired band width for high-definition television. The trap circuits required to eliminate from the image channel the interference caused by its sound carrier, and also by the adjacent-channel sound carrier, are included as part of these transformers.

The units measure 3 1/4" long by 1" wide and 1 5/32" high. Terminals extend from both ends of the shield. The design

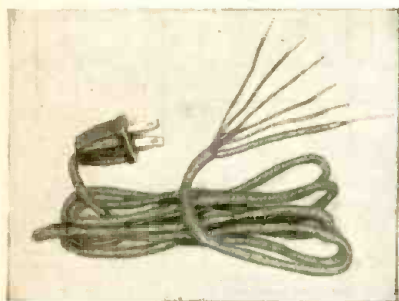

A universal resistor-line cord. (1758)

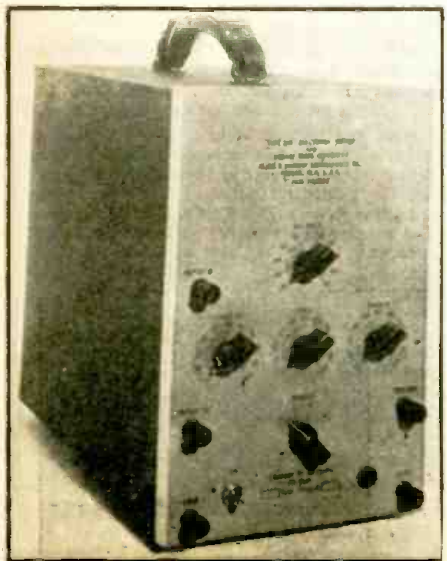

Electronic switch and square-wave generator. (1759)



Top. Terminal guards for high-voltage condensers. (1761) Left. New "Tube Master" checker. (1760) Right. New coaxial cable. (1762)

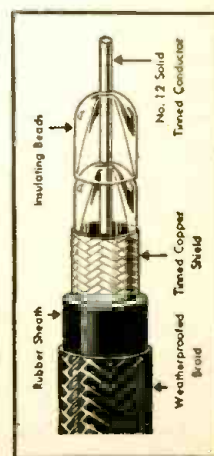



All the worthwhile  
Radio Trade News  
of the past Month—  
Digested for busy  
radio men.

# RADIO Trade Digest

A PLEDGE: — To  
print the important  
news of the radio  
industry; to review  
major news events;  
to help point a path  
to radio profits.

IMPORTANT HAPPENINGS OF THE MONTH IN THE RADIO INDUSTRY

No. 11

JULY, 1939

No. 11

## TELEVISION BOOM STARTS



**SCHOOL** for Servicemen runs for an hour twice a week to teach television to Stromberg-Carlson workers & foremen who will engage in it. Co.'s engineers act as teachers. (Course stresses safety.—Ed.)

### Public Goes Wild Over Test Programs, Though High Prices Slow Buying

The television boom started in New York even before the telly broadcasts were officially begun. Dealers took advantage of telly tests—put sets in stores, signs in windows.

Public dashed into stores, stood slack-jawed, pop-eyed, marvelling at everything visual from 3 x 4" test patterns to 8 x 10" images of prize fight, newsreels, comedy shorts. RTD was most amazed that public was most amazed that sound synched with images. (It would be wonderful if it didn't!)

Sales were being made by some dealers. Others muffed 'em because unready to talk terms. Public did not seem to think prices exorbitant on smaller sets, but wanted plenty

(Continued on page 62)

## Cinema Television is here

**YOU CAN'T SHUT YOUR EYES TO IT**

The historic event of the television transmission by the B.B.C. of the Boon v. Danahar fight was reproduced at the world's first News-Television Cinema, the Monseigneur, Marble Arch, by the Scophony Television System.

**BAFFLING** of chandelier type (in circle) projects sound over 360-degree arc in this Atlas Sound installation by Montross Sound Systems, of Troy, N. Y.

Size for size Scophony provides to-day the brightest television pictures, so there is no need to reduce the auditorium lighting—an important consideration in cinemas. Ease and simplicity of operation akin to Standard Cinema technique. The apparatus can be handled by any cinema operator.

Rear Projection. Normal seating arrangements remaining intact.

**SCOPHONY LTD**  
THORNWOOD LODGE, CAMPDEN HILL, W.8  
Telephone: Park 5294      Telegrams: Scophony, London

INQUIRIES FROM CINEMAS FOR SCOPHONY TELEVISION INSTALLATIONS INVITED

Scophony are pleased to be able to place the results of years of their research in large television screens at the disposal of the cinema trade.

READ WHAT THE PRESS SAY ABOUT SCOPHONY

THE OBSERVER: True television sets are too expensive for what the commercial faults for which the commercial apparatus are not yet equipped. The picture is sharp and brightness of the picture which seemed nearly up to cinema standards. Cinema television has arrived. There can be no doubt about it.

DAILY EXPRESS: Brightness and stability, the answering of questions or interference... where at Maringer and... themselves at night. They called... clipped sound. Without doubt... this is a form of entertainment... should, say to follow... with a tremendous effect.

**GIANT** television on movie screens is commercial in Britain, belittlers to the contrary notwithstanding—& here's Scophony's page trade ad to prove it. Co.'s head, S. Sagall, still plans American organization. Size of original ad, in red & black, 9½ x 14 ins.

### BIZ OPPS

Here's a lead for mfrs. & jobbers:  
**C. Harte & Co., Dintelstraat 108, Kantoor, Amsterdam, want prices on automatic record changers in lots of 2-300—preferably F.O.B. Amsterdam.**

### States to Protect Radios

A glance around the U.S. map shows 44 states pushing laws to help radio mfrs., jobbers, dealers & listeners.

Highlights: Conn. & Minn., law would exempt radios from attachment by creditors (but what might that do to installment sales?). Tenn. would reduce tax on dealers in sets & equip't. Kan. would exempt receiver installations from inspection fees. Conn. would equip

(Continued on page 63)





PRESSES ROLL—TO HELP YOU SELL

TICKET	<b>RECEIPT</b> (Customer Claim Check)		NAME _____ PHONE _____		
	DATE TAKEN _____ DATE RETURNED _____		MAKE _____ MODEL _____		
	WE HAVE TAKEN TO OUR SHOP YOUR RADIO (SET) (CHASSIS)		DATE CALLED _____ DELIVERY DATE _____		
	MAKE _____ MODEL _____ SERIAL _____		ITEMIZATION OF WORK DONE		
JOB	SIGNED _____		SUMMARY OF CHARGES		
	FOR SERVICE RECEPTION REPLACE WITH WORK ON TUBES WITH OUR GUARANTEED NATIONAL UNION TUBE—TUBE ECONOMY AND TUBE ECONOMY. NOT LIMITED TO FUNCTIONAL WITH ORIGINAL PARTS. TUBE REPLACED AT THE NEXT REGULAR SERVICE MAINTENANCE TREATMENT.		Parts	\$	
			Tubes	\$	
			Labor	\$	
Total			\$		
		Sales Tax	\$		
		Grand Total	\$		
		<b>NATIONAL UNION</b> TUBE and CONDENSER QUALITY INSURE GOOD WILL			
Name _____ Address _____ Phone _____		TOTAL PARTS CHARGE \$	TOTAL TUBE CHG \$		

National Union's "4-in-1" job card tears into 3 parts, on perforations. Tag, left, ties to chassis; receipt, center, given to customer as check; job record, right, fits your standard 3x5 card file—a swell system for follow-ups.

<p><b>It's Good Business to Keep a Job Record!</b> NATIONAL UNION 4 IN 1 JOB CARD</p> <p>THIS IS A CONVENIENT FORM WHICH SUPPLIES THE FOUR MOST IMPORTANT RECORDS ON THE SINGLE JOB CARD. A JOB RECORD TO BE REFERRED TO BY THE SERVICE MAN WHEN TAKEN FROM THE MAIN JOB RECORD. A RECEIPT ON "CUSTOMER CHECK" GIVEN WITH THE SERVICE WORKING PART WHEN TAKEN FOR SERVICE AND RETURNED WITH DATE OF RETURN WHEN TAKEN BACK TO CUSTOMER. A GUARANTEED FORM ON WHICH TO JOB DOWN THE CUSTOMER'S SERVICE WORK DONE AND GUARANTEED TIME TO BE GIVEN TO REPAIR.</p> <p>THIS JOB RECORD CARD IS A STORED KNOWLEDGE OF THE FOUR CUSTOMERS AND WHEN YOU NEED SOME FOR TUBE AND OTHERS, USE RECORD OF SERVICE TO GET THE CUSTOMER'S NAME AND ADDRESS. WHEN YOU NEED TO KNOW WHERE AND HOW TO GET THE CUSTOMER'S NAME AND ADDRESS, USE RECORD OF SERVICE TO GET THE CUSTOMER'S NAME AND ADDRESS. WHEN YOU NEED TO KNOW WHERE AND HOW TO GET THE CUSTOMER'S NAME AND ADDRESS, USE RECORD OF SERVICE TO GET THE CUSTOMER'S NAME AND ADDRESS.</p>	<p><b>RADIO REPAIR AND SERVICE</b> Date _____</p> <p><b>Guarantee</b></p> <p>THE RADIO SERVICE AND REPAIR WORK SPECIFICALLY DESCRIBED BELOW IS GUARANTEED BY THE NATIONAL UNION TUBE AND CONDENSER COMPANY FOR A PERIOD OF 90 DAYS FROM DATE INDICATED HEREON. THIS GUARANTEE IS FULLY VALID ONLY WHEN THE WORK DONE HEREON IS WITH NATIONAL UNION TUBES AND CONDENSERS. THE TIME LIMIT SET BY THE GUARANTEE IS UNLIMITED EXCEPT TO MAKE OR REPLACE ANY OF CHARGE PARTS PROVIDED REASONABLE DUES AND FEE ARE PAID TO THE COMPANY.</p> <p>DESCRIPTION OF SERVICES</p> <p>Signed _____</p>	 <p><b>NATIONAL UNION</b> TUBES and CONDENSERS</p> <p><b>INSIST ON</b></p>
	<p>SERVICE NOTES</p> <p>_____</p> <p>_____</p> <p>_____</p>	

Other side of card. Explanation of system & space for notes on back of job record; guarantee on back of customer's claim check; plug for N.U. tubes on back of chassis tag.

GIVE GUARANTEE—ADVERTISE IT

**Guarantee**

The service work we have completed on your radio as specified below is guaranteed against defective workmanship and material for \_\_\_\_\_ days from date delivered providing all charges have been paid in full.

We will replace or repair defective parts or tubes free of charge under the above guarantee. This applies only to parts and tubes installed at this time. This guarantee does not, of course, cover damages resulting from accidents, attempted repairs, neglect or abuse by the owner.

It is our aim to give prompt and reasonable service. This guarantee is your assurance of our sincere effort.

Date Delivered \_\_\_\_\_ Signed \_\_\_\_\_

Tubes or Parts Installed and Service Work Performed: \_\_\_\_\_

\_\_\_\_\_

\_\_\_\_\_

Customers don't mind paying for service when work is Guaranteed good. Hygrade Sylvania offers 100 folders, 100 guarantees, 1 certificate, for \$1.25. Here's the guarantee, and below—

<p><b>RADIO CHECK-UP AND GUARANTEE</b></p> 	<p>Name _____ Address _____ Radio _____ Model _____</p> <p>On the reverse side of this sheet is our guarantee of the service work done on your radio. As an additional step in our effort to give you good radio performance, this sheet includes a list of those little things that are sometimes overlooked when more serious repairs are required. A check mark (✓) on the list below indicates that the item is OK. A cross (X) indicates that repair or renewal is recommended to avoid future trouble to your set.</p> <p>Y=OK. X=Repair or renewal recommended.</p> <p>Check each item after Repair Job:</p> <p>Alignment _____ Broadcast Pickup _____ Short Wave Pickup _____</p> <p>Wave Band Switch _____ Volume Control Action _____ Tone Control Action _____ Tuning Mechanism _____ Tube Shields _____</p> <p>Tube Types _____ Pilot Lights _____ Batteries _____ Grid Cup Leads _____</p> <p>Speaker Rattles _____ Dial Adjustment _____ Speaker Leads, etc. _____ Chassis Dust _____ Cabinet Scratches _____</p> <p>Photograph Operation _____</p> <p>Check after Installation:—</p> <p>Antennas _____ Ground _____ Lightning Arrestor _____ Instruct in operation of receiver _____</p> <p>Notes _____</p> <p style="writing-mode: vertical-rl; transform: rotate(180deg);">Have Your Tubes Tested Twice a Year</p>
	<p>you see the radio check-up form, printed on the back of the guarantee. Two-color folder features these forms, with copy stressing Responsibility, Competence, Reliability; fits No. 10 envelope. At right is 8 1/2x11 Certificate to frame &amp; hang.</p>

Trade Slants from the RSA

Williamsport, Pennsylvania, Chapter: held meeting in Radio Station WRAK. Mr. Joy and Mr. Persio, Station Manager and Chief Operator, spoke on cooperation between local broadcasting stations and Servicemen. Chapter agreed to furnish articles on interesting radio topics in exchange for "plugs" on the air for RSA.

Stuebenville, Ohio, Chapter: continued discussion of how to combat tube discounts to the retail trade at recent regular meeting. The Committee appointed to investigate the source of local interference to radio reception, reported that the source had been found and methods of remedy were discussed.

Green Bay, Wisconsin, Chapter: A campaign to tell the people of Green Bay and vicinity about RSA is now under way. Chapter is using newspaper articles and advertising; also on the air with spot announcements. Each member pays for his own announcement and only one man participates each day. A member can say any—

(Continued on page 63)

Sales Helps and Deals Aids To Profits, as Devised By Industry Leaders

Those no-aerial, battery portables have opened a brand new biz—rentals to commuters, who must be on the train while their favorite program is on the air—and who don't want to miss either one. (Or, heck, sell 'em a set!)

WQXR, only special high-fidelity station in N.Y. area, bests on 1,550 kc.—& many sets won't tune that low. So Servicemen are altering 'em. (See story in July '38 R.-C. on how to do it—Ed.) The station itself has a service dept. to do the job for \$3.

Watch for National Union's new radio tube proposition. It'll feature new prices, protected profits, & minimum investment.

Same co. is supplying postcards to use in asking questions of your jobber. A mighty good idea, that.

Hygrade Sylvania is having a putsch on panel lamps, & suggests replacing all when a set is serviced. Window streamers & counter cards are available to help you sell.

(Continued on page 62)

FOR CUSTOMER CONFIDENCE

**Our Guarantee**

All service work completed by this shop is covered by a written guarantee as to workmanship and quality of parts and materials used.

Signed \_\_\_\_\_

We Use and Recommend Sylvania Radio Tubes



# AN EDITORIAL

By Artie Dee

The knife is out!

As soon as the debut of television was announced, some of the boys got out their hammers and stood by, to knock it on the head before it could get started.

Don't let it bother you. There are knockers in every industry, and radio is no exception. The only unfortunate feature is that these knockers are, in some instances, highly placed.

**Fox & Grapes** Remember that a knocker always has a reason. Aesop's fabled fox went around complaining that the grapes he could not reach "were sour, anyway."

This may or may not be the case with television's detractors. It is perfectly possible that they really believe television still to be 5 years away. But others, more prominent and more numerous, believe that television is ready for the public and that the public is ready for television.

Figure it out for yourself. RCA—G-E—Westinghouse—Stewart-Warner—Pilot—Stromberg-Carlson—Emerson—Phileo—Andrea—DuMont—some of the most famous names in radio—are producing entire lines of television receiving equipment. If they did not believe that television was ready, and the time ripe, they would not be spending many thousands of dollars in this branch of the industry.

On the other side of the fence is the president of an equally noted radio company—but, mark you, just one president of one radio company. He is now putting on a drive to get the NAB behind him. (It is RTD's guess that the NAB and its president, Neville Miller, have too much sense to fall for this gentleman's very persuasive line of chatter.)

(Continued on page 63)

## Changes & New Addresses

Save stamps & time! Address your mail right the first time!

**CLOUGH-BRENGLE CO.** has moved to new quarters at 5501 N. Broadway, Chicago, Ill. It's a "more favorably situated location," they say.

**R. H. KYLE & CO.**, Charleston, W. Va., has become a distributor of Stewart-Warner Corp. products.

**BRADY ELECTRIC CORP.**, 302-304 Railroad Av., Elmira, N.Y., is also a new Stewart-Warner distributor.

**UNITED CATALOG PUBLISHERS** has moved to 230 5th Av., N.Y.C. Biz includes special jobbers' catalog service, & publish "Radio's Master Encyclopedia" & "Photopedia"—on cameras.

**INSULINE CORP. OF AMER.** is now in larger quarters at 30-30 Northern Blvd. at Queensboro Plaza, Long Island City, N.Y., with twice as much machinery & mfg. facilities as ever before.

**H. L. HILDENBRAND**, 36-43 212th St., Bay-side, L.I., N.Y., now represents Esterline-Angus Co. (recording meters) in Metropolitan N.Y.

## THE MORE YOU TELL—THE MORE YOU SELL



Balky Burro, Crooning Cur, Petulant Pig, advertise radio faults & recommended panacea—National Union tubes. They're lithoed in 4 colors.



Amperite Kontak Mike display is 11x17, in 2 colors; mikes should sell well for outdoor applications now. RCA Radiotron cards (center piece shown) use circus theme, are lithoed in 8 colors, while Cunningham cards use sport theme. Not shown is RCA Victor tube card, featuring recording artists. Four units in each group cost \$3 per set, with "Service" streamer.

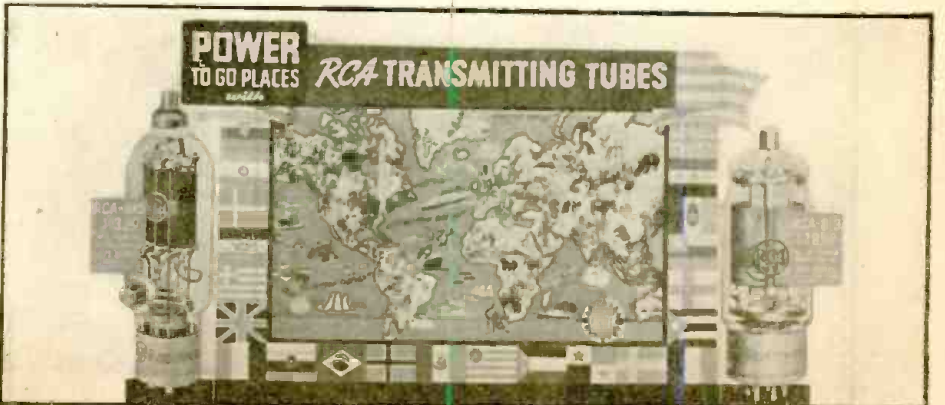

Nine-color litho display advertises RCA Xmitting tubes. This one measures 18x35 inches to dominate window.



**FACSY KIT READY**

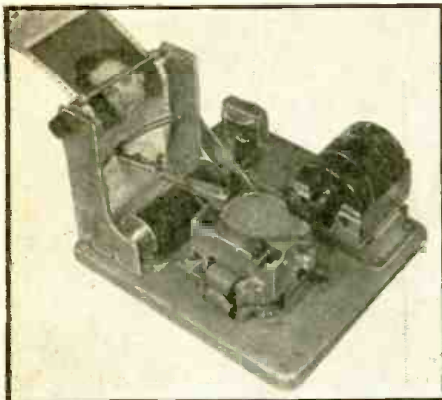

Crosley Corp. is using the Finch system in its Reado—now available in kit form for \$49.95 (not \$39.50). Unit, when completed, operates from output of any average broadcast receiver, to print paper right in the home.

**PUTS GERMS ON SPOT**



Westinghouse "Sterilamp" (mercury vapor) uses less than 2 1/2-kw. per month as, operating continuously, it kills mold, germs, etc.—thereby making itself a ready sideline seller. Similar system has been proved in hospitals.

**SNOOPS & SCOOPS**

*CBS deal for taking over control of World Bestg System fell through. . . G-E reps are peddling clock time-switches to grain dealers who don't want to miss market reports, and why don't YOU try it on the local yokels?*

*Hygrade Sylvania Corp. will gain 50,000 sq. ft. in a new office bldg. added to its factory at Emporium, Pa. . . And Sprague Specialties Co. has a new factory at North Adams, Mass. . . The Perry Bill, which seeks to prohibit recording of artists in N.Y. state without their permission, is getting a battle from Audio-Scriptions, Inc., which claims the law will foster monopoly.*

*You may pick up some biz by cashing-in on the foreign nations' tributes to the World's (G. Whalen's) Fair, by hitting the foreigners in your town at the right time. The Fair'll send you a schedule—or if they miss up, NBC, which broadcasts 'em, will.*

*(Continued on page 63)*

**Personal**

*These men are worth knowing; meet them here.*

**HARRY C. HART**, former instructor of Electrical Engineering at the U. of Penna., has opened a patent law office in the RCA Bldg., Radio City, N.Y.

**SAUL SHAPIRO** won the singles, and **CARL OSWALD & DON BOLES** the doubles, of the Universal Microphone Co.'s annual tennis tournament. Saul is factory rep.; Carl & Don, technical assts.

**PETER HOLLAND**, treas. of Muzak, has replaced **JOSEPH D. R. FREED** as v-p & gen. mgr. Resigned with **FREED** are his asst., **JOSEPH KOEHLER**, head of the promotional dept., & **FREED'S** secy.

*(Continued on page 64)*

**\$'s & N<sup>o</sup>. 's Dept.**

**RCA EMPLOYEES** received a simplified balance sheet, summing up biz for '38. It showed Assets of \$90,799,500; Income of \$99,968,100; Expenses of \$92,566,000 of which \$30,780,000 was for salaries; net earnings of \$7,412,100. More than \$50 million was spent on materials, rent, etc.

**250 G's MORE** business was done in 1st 1/4 of '39 by Belmont Radio Corp., which took in \$1,125,290. In '38, it was only \$865,570 in 1st 1/4.

**PROFIT IN** 1st 1/4 of '39 was \$146,275 for Stewart-Warner, as compared with loss of \$215,166 in same period of '38. Radio sales showed 300% increase!

**NETWORKS:**—NBC biz increased 78.5% in 1st 1/4, the billing being over \$11 1/2 million. CBS dipped to \$9,705,793—but only a few % below '38.

**RADIO CO.'S CAMERA**

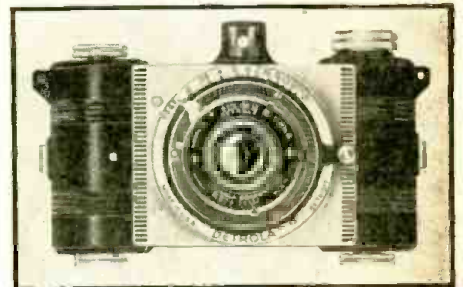

Detrola Corp. is latest radio mfr. to enter photo field. Camera with F:4.5 lens is leader at \$9.95; others range from \$3.95 to \$19.50.

**LATEST PUBLICATIONS**

**VOCAGRAPH SOUND SYSTEMS**—1939 De Luxe Models. Vocagraph Sound Systems, 164 N. May St., Chicago, Ill. 4 pp. Lists numerous models from 5 to 100 watts output; 6-volt, 110-volt; some with record players.

**ELECTRICAL & RADIO WORLD TRADE NEWS**, U.S. Dept. of Commerce, Washington, D.C. 60 pp. (25 devoted to radio). Statistics on radio, sales, business, saturation, etc. This is 5th annual statistical number (Vol. 11, No. 11). *(Continued on page 64)*

**DUAL DEAL—HEIGH-HO SILVER!**

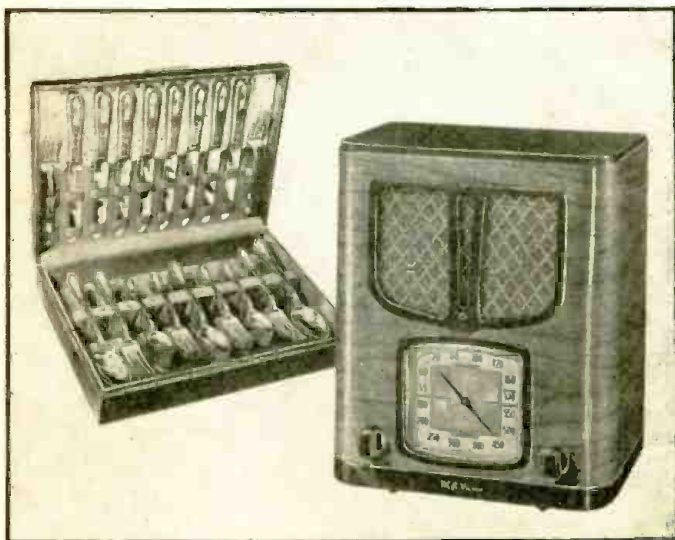

Battery-operated RCA Victor farm model 94BT-1 sold with 51-piece has been tested as deal in rural areas & found success. Wall displays, folders & ad mats plug the combo offer, at cost slightly above radio alone.

**PHONO-RADIOS SELL CANNED FOOD**



Every Hormel salesman carries a phono-radio & record into grocery to sell new radio ad program plugging "Spam", a canned meat product. Records give sample of CBS broadcast & explain campaign to the retailer.



**SUPERIOR PRESENTS 5 INSTRUMENTS** from its NEW 1939 1100 series!!!!!! Never before has Superior offered so much for so little! Always the Best Buy in the Instrument Field, Superior in this new 1100 series gives you even more value! We have incorporated many refinements, many new features . . . all proven to be sound and practical. We urge you to read the descriptions below carefully; see how these instruments fit your needs. Buy direct from manufacturer and save 50%.  
**Superior Instruments Are Guaranteed for One Year**

**THE NEW X-RAYOMETER**

**Features:**

★ **GIANT 9" D'ARSONVAL TYPE METER**

★ Built-in power supply enables resistance measurements up to

**30 MEGOHMS**

(Without external batteries or power supply)

- ★ 1/2 Ohm easily read on low ohm scale
- ★ D.C. volts up to 2500 volts
- ★ A.C. volts up to 1000 volts
- ★ D.C. currents up to 25 amperes
- ★ 2 Capacity Ranges. Micas, papers, electrolytics read up to 50 Mfd. 2% ACCURACY.
- ★ PERCENTAGE OF LEAKAGE of electrolytics read DIRECTLY on scale.
- ★ Insulation, Inter-elements and all other leakages directly read up to 30 megohms.
- ★ 4 Output Ranges up to 1000 volts.
- ★ 2 Inductance Ranges up to 703 Henries.
- ★ 3 Decibel Ranges
- ★ Cathode Ray high voltage power supplies easily measured.

**SPECIFICATIONS:**

Resistance measurements in three ranges: 0-1000 ohms, 0-100,000 ohms, 0-30 megohms. Less than 1 ohm easily read on meter scale. D.C. Voltage measurements in five ranges: 0-50/0-250/0-500/0-1000/0-2500 Volts. Television and other high voltage power supply circuits easily measured. A.C. Voltage measurements in four ranges: 0-50/0-250/0-500/0-1000 Volts. D.C. current measurements in five ranges: 0-50/0-250/1 Amp/10 Amps/25 Amps. High current ranges suitable for automotive and industrial work. Capacity directly read on meter scale in two ranges: .005-1 Mfd./2 Mfd.-50 Mfd. Percentage leakage of electrolytic condensers directly read on meter scale. Actual condition of condenser quickly determined. Insulation, inter-element and A.C. leakages directly read on meter scale up to 30 megohms. Without measurements in four ranges: 0-50/0-250/0-500/0-1000 Volts. Built-in blocking condensers enable rapid alignment of radio equipment. Inductance measurements in two ranges: 1-7 Henries/7-703 Henries. Decibel measurements in three ranges: -10 -- -20/ -10 -- +43/-10 -- +49. Audio frequency measurements in both radio and P. A. amplifier. X-Rayometer utilizes an etched aluminum panel and comes housed in a new army grey crystalline, heavy-gauged cabinet. Complete with test leads and instructions. Size 13 3/4" x 10" x 6". Shipping weight 20 pounds. Our net price . . . . .

**\$17.95**

**THE NEW MODEL 1130-S SIGNAL GENERATOR WITH AUDIO FREQUENCIES**

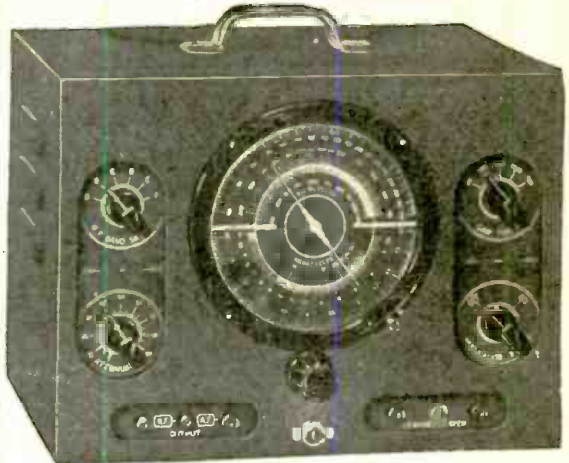

**SPECIFICATIONS**

1. Combination R.F. and Audio Signal Generator, R.F. 100 kc. to 100 Mc., A.F.—100-7,500 cycles. All Direct reading, all by front panel switching
2. R.F. and A.F. output independently obtainable alone or with A.F. (any frequency) modulating R.F.
3. Accuracy is within 1% on I.F. and Broadcast bands; 2% on higher frequencies.
4. Audio frequencies in 5 bands: 100, 400, 1000, 5000, and 7500 cycles.
5. Giant airplane full vision, direct-reading dial.
6. Condenser and other leakages tested to 100 megohms.
7. All services on 90-130 volts A.C. or D.C. (any frequency).

Model 1130-S comes complete with tubes, test leads, carrying handle, instructions. Size 12" x 9" x 6 1/2". Shipping weight 15 pounds. Our net price . . . . .

**\$11.85**

**THE NEW MODEL 1150-S SUPER-ALLMETER**

Featuring the New Sloping Panel



A genuine achievement! For accurate and rapid measurements. Note the following features: A.C. and D.C. Volts. A.C. and D.C. currents. Resistance. Capacity. Inductance. Decibels. Watts.

**SPECIFICATIONS:**

- D.C. Voltage: 0-15, 0-150, 0-750 volts D.C.
- A.C. Voltage: 0-15, 0-150, 0-750 volts A.C.
- D.C. Current: 0-1, 0-15, 0-150, 0-750 ma. D.C.
- A.C. Current: 0-15, 0-150, 0-750 ma. A.C.
- 2 Resistance Ranges: 0-500 ohms  
500-5 megohms
- High and Low Capacity Scales: .0005 to 1 mfd. and .05 to 200 mfd.
- 3 Decibel Ranges: -10 to +19, -10 to +38, -10 to +53.
- Inductance: 1 to 700 Henries
- Watts:

Based on 6 mw. at 0 D.B. in 500 ohms. .006000 to 600 Utilizes new 4 1/2" square 0-1 d'Arsonval type meter with precision resistors housed in our newly devised sloping case for rapid and accurate servicing.

Model 1150-S supplied complete with test leads, tabular charts and instructions. Size 10" x 7 1/4" x 4 1/4", shipping weight 9 pounds. Our net price . . . . .

**\$11.85**

**THE NEW MODEL 1180-S SET TESTER**

A Complete Laboratory All in One Unit!

Featuring Our New Type Sloping Panel for Precise and Rapid Servicing



A complete testing laboratory all in one unit! Combines Superior models 1140-S and 1150-S. For specifications read the description of both these models here-with. Comes housed in sturdy, black case with sloping panel for rapid and simple measurements. Complete with test leads, tabular charts, instructions and tabular data for every known receiving type tube, including many transmitting types. Size 11 1/2" x 9 1/4" x 5"; shipping weight 18 pounds. . . . . Our net price . . . . .

**\$17.85**

Portable Cover, add 95c.

**THE NEW MODEL 1140-S TUBE TESTER**



A really modern tube tester conforming to all standards of good engineering practice. Utilizes a 3" d'Arsonval type meter with calibrated scale. Furnished in a sturdy black case with sloping panel for easy operation. Removable cover and carrying handle for either portable or counter use.

**SPECIFICATIONS:**

1. Tests all 4, 5, 6, 7, 7L, octal and loctal base tubes, including diodes.
2. Tests by the well-established emission method for tube quality, directly read on the GOOD? BAD scale of the meter.
3. Affords separate neon test for leakage and shorts between elements.
4. All services performed by the use of only five controls at maximum, and many tests do not require working all the controls.
5. Supplied with instructions and reference table so that the filament voltage and emission measuring controls may be properly set for the enumerated long list of tubes, which includes all tubes commonly encountered in servicing.
6. Works on 90-120 volts A.C. 60 cycle.

Model 1140-S comes complete with instructions and tabular data for every known receiving type of tube as well as many transmitting types. Shipping weight 10 pounds, size 10" x 7 1/4" x 4 1/4". Our net price . . . . .

**\$10.85**

Portable Cover, 75c additional.

**SUPERIOR INSTRUMENTS CO.**

136 Liberty St., RC-7  
NEW YORK, N. Y.

Please Say That You Saw It in RADIO-CRAFT





# Jim tells Joe

About Sylvania's New Characteristics Sheet

**JIM:** Say, Joe—take a look at this new Tube Characteristics Sheet! Isn't it a honey?

**JOE:** Hm-mm. This is good! Here's complete operating characteristics for all Sylvania tubes—even data on the Loktal, Cathode-ray and other new tubes.

**JIM:** Yep. And in the back here are base and bulb diagrams for all types—and complete dope on Sylvania panel lamps, too!

**JOE:** Sa-ay—this would be a big help to my business! Where can I get it and how much does it cost?

**JIM:** It's free—one of Sylvania's many serviceman helps. All you have to do is send to Hygrade Sylvania Corporation, Emporium, Pa. I'm telling you, Joe—better do it today!



**IT'S FREE!  
CLIP THIS  
COUPON**

**HYGRADE SYLVANIA CORP.** RC-79  
Emporium, Pa.

Please send me your new Sylvania Characteristics Sheet.

Name .....

Address .....

City ..... State .....

Serviceman     Dealer  
 Amateur        Experimenter

Name of Jobber .....

## SYLVANIA

SET-TESTED RADIO TUBES  
Also Makers of Hygrade Lamp Bulbs

## \$4,000 P. A. CONTEST

(Continued from page 21)

installation and to emphasize the fact that ANY radio man can engage in this profitable activity, Radio-Craft has instituted this contest.

There are no strings attached—anyone with the ability to make a public-address installation is eligible. The contest rules are explained below.

Radio-Craft feels that many individuals and organizations have made public-address installations introducing equipment or set-up innovations, or employing P.A. apparatus, which meet entirely new and novel conditions; or other worthwhile P.A. installations. Therefore, in order to give our readers first-hand information we plan to run a series of articles based on the winning entries of this contest.

In order that these may be the cream of public-address installation articles, valuable awards are being given each month, for four (4) consecutive months. These awards will be made available through the co-operation of well-known manufacturers of public address and sound equipment.

For this reason, every Serviceman, dealer, public-address specialist or group of specialists capable of making what may be considered a worthwhile public-address installation will find it profitable to enter this contest.

### Contest Rules

#### Section No. 3 (July)

- (1) Write a letter of not more than five hundred (500) words, exclusive of list of components, describing in detail a practical public-address installation, whether it be rental, permanent, or portable. Give the date when the order was received.
- (2) Outline in the letter the business angle of the deal:
  - (A) How and where you got the lead, how you followed it up, and how you clinched the sale. *Clients' names need not be mentioned.*
  - (B) Cost of apparatus, sale price, profit involved. In fact, give all the details which will guide other men in the radio field in undertaking similar work.
- (3) Outline the technical angle of the deal:
  - (A) Purpose of installation.
  - (B) Technical problems involved.
  - (C) Choice of equipment and reasons for use of same.
  - (D) How installation problems were solved.
- (4) Letters will be judged strictly on the merits of the installation jobs, i.e.: the choice of properly-rated equipment for the particular service to be rendered, ingenuity in solving installation problems, also initiative and business ability displayed in consummating the deal. Literary style or manner of presentation will not be considered.
- (5) Photographs and diagrams, although not requisite to this contest, are desirable and shall be considered as a permissible influence upon the judges.
- (6) All letters, photographs or diagrams submitted become the property of Radio-Craft. None can be returned.
- (7) This contest is not open to the officials or employees of Radio-Craft Magazine

## DATAPRINTS



### TESLA-ODUDIN HI-FREQ. COILS

- 20c Ea. in order for 10 (Data and Drawings only.)
  - 36" Sp'k Tesla-Oudin Coil 40c (1 K.W. Exc. Trf. Data, included FREE!)
  - 8" Sp'k Tesla-Oudin Coil 40c (1/4 K.W. Exc. Trf. Data, included FREE!)
  - 3" Sp'k Oudin; 110 Vt. "Kick Coil" type 40c
  - 3" Sp'k Tesla Works on Ford Sp'k Coil 40c
  - 1" Sp'k Violetta Hi-Freq. Coil 40c
- FREE with order \$1.00 or more—20 Tricks with Hi-Freq. Coils (40c separate)

**20 ELECTRIC PARTY AND LODGETRICKS!**  
How to Shock 'em! Loads of Fun! 40c

**Television Hook-Up—Sight & Sound** 40c

Special Prices: 4 prints \$1.00; 10 for \$2.00; 40c each, single orders.

**The DATAPRINT Co.**

Lock Box 322C, Ramsey, N. J.

**MYSTIC MIKE OUTFIT**

Now! Thrill friends! Have your own broadcasting station. Amazing invention enables you to do your own broadcasting from any part of your home—WITHOUT WIRES. Simply plug this unit into any electric outlet, speak into the microphone and your voice will be picked up by any radio ANYWHERE in your home. Complete with tube and microphone—ready to broadcast \$3.95 postpaid. Money back guaranteed! Mystic Mike Co., 362 Wooster Ave., Akron, Ohio

**3 95**

**LES**

**Correspondence Courses in RADIO and ELECTRICAL ENGINEERING**

**ELECTRICAL ENGINEERING** Get good grasp of wide electrical field. Prepare yourself, at Low Cost, for secure future. Modern, simplified, you can understand quickly.

**RADIO ENGINEERING** Extra fine course in radio, public address, photo-electric work.

Trains you to be super-serviceman, real vacuum tube technician. Expend. kits furnished. Diploma on completion. Tuition, \$25, either course. Deferred payment plan.

**FREE** Get copies of school catalogs, student magazines, complete details. SEND NOW!

LINCOLN ENGINEERING SCHOOL, Box 931-C7, LINCOLN, NEBR.

## NEW CIRCUITS IN MODERN RADIO RECEIVERS

(Continued from page 30)

to the input grid coil of the triode detector section. Some of the R.F. energy at the plate is thus fed back to the grid causing regeneration. However, the values of parts and their arrangement is such that oscillation cannot take place normally. The regeneration is only sufficient to increase the selectivity and gain practically equivalent to another tuned stage.

### (5) PADDING FOR COMPLETE R.F. SYSTEM

Motorola Model 8-70. A padding condenser is used in series with each tuned circuit of the R.F. as well as for the oscillator in this receiver. This provides for a more exact tracking adjustment over the complete band than the usual oscillator adjustment.

In Fig. 2B, where the circuit is shown, condensers P1, P2 and P3 are the series padders for the Ant., R.F. and Osc., respectively, corresponding to the main tuning condensers C1, C2, and C3 for the same stages. Note that their values of capacity are quite large as compared to the trimmers. This is the only type of circuit that can be accurately adjusted at low frequencies without shifting or bending the condenser plates.

In the oscillator stage, there is an additional trimmer (T) for compensating for changes in other oscillator circuit capacities, due to temperature changes.

**SERVICEMEN:** If you spot any new features in circuits with which you come into contact, please be good enough to bring them to the attention of this department for special treatment—help us give you a still better magazine.—  
The Editors

Please Say That You Saw It in RADIO-CRAFT



nor to any officials or employees of the companies submitting prizes for this contest.

- (8) The final closing date of this contest is midnight August 10th, 1939. All letters entered in this contest must be addressed to the PUBLIC ADDRESS CONTEST EDITOR, RADIO-CRAFT Magazine, 99 Hudson Street, New York, N. Y., and must bear the postal cancellation stamp not later than midnight, August 10th, 1939.
- (9) Section No. 3 of this contest opens June 11th and closes July 10th; Section No. 4, to be announced in the August issue, opens July 11th and closes August 10th; Postmarked dates will be considered conclusive.
- (10) A board of judges will decide the winners and their decisions are final.
- (11) THE JUDGES FOR THIS MONTH'S CONTEST  
E. G. Brown, Montgomery Ward & Company  
Jack V. Dahlstrom, The Radolek Company  
John Meek, Vocograph Sound Systems
- (12) A complete list of winners of Section No. 1 (May-issue contestants) will appear in the August, 1939 issue. Winners of Section No. 2 (June-issue contestants) will appear in the September, 1939 issue. Winners of Section No. 3 (July-issue contestants) will appear in the October, 1939 issue. Winners of Section No. 4 (August-issue contestants) will appear in the November, 1939 issue.

### List of Prizes

(Continued from page 21)

- 2 ELEVENTH PRIZES—Auto-Top Carrier for Mobile Sound Installations, platform size 30 x 54 ins., type PA26, \$22.50  
*Offered by Vac-O-Grip Company*  
Velocity Microphone, model 20, \$22.50  
*Offered by Allied-Burns Company*
- 2 TWELFTH PRIZES—Auto-Top Carrier for Mobile Sound Installations, platform size 30 x 36 ins., type PA22, \$16.00  
*Offered by Vac-O-Grip Company*  
12-In. P.M. Speaker, type FB12-M, \$16.00  
*Offered by Cineaudagraph Corp.*
- 2 THIRTEENTH PRIZES—Velocity Microphone, model 10, \$12.50  
*Offered by Allied-Burns Company*  
"Marine Midget" Speaker Horn and Unit, type WX5SP, \$12.50  
*Offered by Atlas Sound Corp.*
- 18 FOURTEENTH PRIZES—Gernsback's Official Radio Service Manuals—Volume 7 (\$10.00 each) \$180.00  
*Offered by Radercraft Publications, Inc.*
- 3 FIFTEENTH PRIZES—Chrome Floor-Type Microphone Stand, model EF-17, \$12.50  
*Offered by Eastern Mike-Stand Company*  
Chrome Floor-Type Microphone Stand, model EF-17, \$12.50  
*Offered by Eastern Mike-Stand Company*  
Chrome Floor-Type Microphone Stand, model EF-17, \$12.50  
*Offered by Eastern Mike-Stand Company*
- 3 FIFTEENTH PRIZES—Desk-Type Microphone Stand, type ED-127, \$3.75  
*Offered by Eastern Mike-Stand Company*  
Desk-Type Microphone Stand, type ED-127, \$3.75  
*Offered by Eastern Mike-Stand Company*  
Desk-Type Microphone Stand, type ED-127, \$3.75  
*Offered by Eastern Mike-Stand Company*

COME ON, all you Servicemen and sound men! Get in on this Contest and win a valuable prize—it may be a complete P.A. system ready to go. Write up that last P.A. sound installation, whether it was a rental, portable, or permanent installation. You still have time to enter the Contest—but rush.

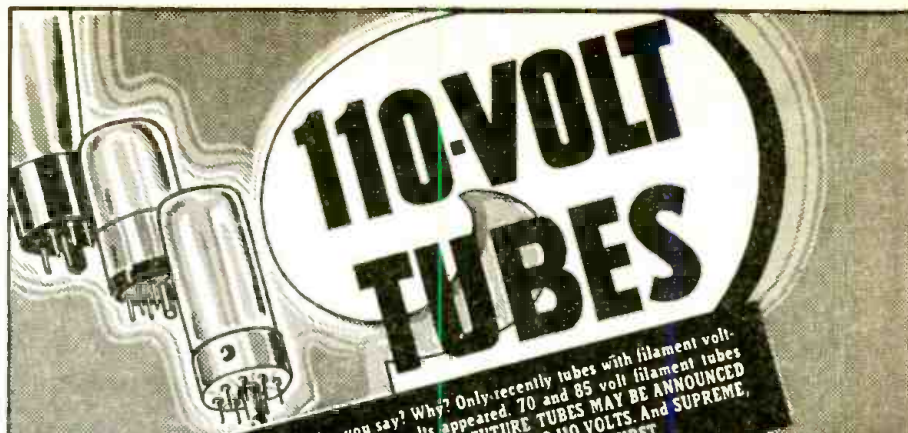

Impossible, you say? Why? Only recently tubes with filament voltages of 35 and 50 volts appeared. 70 and 85 volt filament tubes have now been announced. FUTURE TUBES MAY BE ANNOUNCED WITH ANY FILAMENT VOLTAGE UP TO 110 VOLTS. And SUPREME, as usual, comes to the aid of the serviceman FIRST.

A new SUPREME engineered circuit, known as the OBSOLESCENCE-FREE FILAMENT VARIVOLT SELECTOR, WILL TAKE CARE OF ANY TUBE REGARDLESS OF ITS FILAMENT VOLTAGE FROM 1.5 TO THE FULL LINE VOLTAGE OF 110 VOLTS!

Thus with the new and improved SUPREME 504 Tube and Set Tester and the 503 Tube Tester, you have POSITIVE ASSURANCE AGAINST HI-VOLTAGE FILAMENT OBSOLESCENCE!

Remember "Roaming Filaments"? Remember how SUPREME warned its customers, at the outset of the octal tube announcement, that TUBE BASE TERMINATIONS (particularly filaments) WOULD "ROAM"?

SUPREME completely guarded against tube tester obsolescence due to roaming tube base terminations as soon as it was possible by including in every SUPREME tube tester an OBSOLESCENCE FREE FILAMENT RETURN SELECTOR—the first in the field with complete assurance against obsolescence due to roaming tube terminals.

Once more, SUPREME is the first in the field with positive assurance against obsolescence, this time, due to varying filament voltages.

To keep faith with past purchasers of SUPREME tube testers against their early obsolescence due to hi-voltage filament type tubes, we have arranged a modernization program available to every owner of a SUPREME tube tester which incorporates the SUPREME FILAMENT RETURN SELECTOR.

When you consider the purchase of a new tube tester, remember that SUPREME Tube Testers which are now over 4 years old are still not obsolete!

Join the SUPREME family of satisfied users TODAY! Your jobber can show you the many other advantages of the SUPREME 503 Tube Tester with its Roll Chart, Arrow-way testing system, 7 way tube test, dual sensitivity leakage test, fingertip operation and low cost. He will show you the many extra features of the SUPREME 504 Tube and Set Tester with its 31 functions and ranges on two rows of push buttons, its complete electrolytic and electrostatic leakage check, its guaranteed rectifier, its low per-range cost and a host of other features YOU NEED! And, remember, every SUPREME instrument can be purchased on easy S.I.C. Time Payments—no more daily than the cost of your cigarettes or your phone.

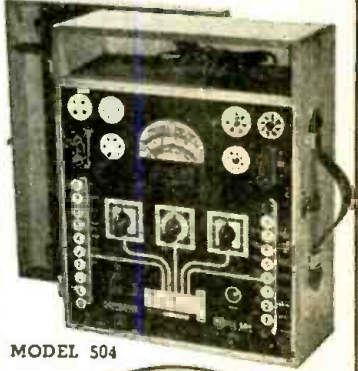

MODEL 504

WHAT IS THE NEW VEDOLYZER RADIO TESTING SYSTEM? See it demonstrated at Booths 212-214 Chicago Radio Show—June 14th to 17th. Hear it explained by B. O. Burlingame Saturday, June 17th, 4:30 P.M. at the Lecture Hall. If you can't visit the Show, write us and we will send you FREE a copy of this lecture together with a complete set of illustrations and reference charts.

## SUPREME

SUPREME INSTRUMENTS CORP. GREENWOOD, MISSISSIPPI, U.S.A.

EXPORT DEPT., Associated Exporters Co., 145 W. 45th Street, New York, Cable Address: LOPREM, N.Y.

### MAIL COUPON TODAY!

SUPREME INSTRUMENTS CORP., Dept. C-6 Greenwood, Miss.  
Please RUSH me your newest information on SUPREME 504 and many other completely new SUPREME 1939 Models.  
Name \_\_\_\_\_  
Address \_\_\_\_\_  
City \_\_\_\_\_ State \_\_\_\_\_

## Be a RADIO EXPERT - Learn AT HOME

**RADIO SPECIALISTS NEEDED** HERE IS YOUR OPPORTUNITY  
Modern receivers with their complicated circuit systems have knocked out the old time cut-and-try radio fixer. Trained men with up-to-the-minute knowledge are needed to service these new sets. Your possibilities of making money and getting ahead are limited only by your ability and skill—but you must know more than the other fellow. You must be a radio service specialist, as R.T.A. can train you.



**FREE**  
OF EXTRA COST

To start you making money without delay we equip you with this Circuit Analyzer and Point to Point Resistance Tester.

### PRACTICAL TRAINING AT HOME

Our home study course is practical "shop and bench" training combined with a thorough set of practical lessons prepared by an experienced Radio service engineer. Four working outfits are also furnished.

### MAKE SPARE TIME MONEY

Our training is complete and practical. We show you how to make money almost from the start. The course can easily be made to pay its own way. Investigate now, write for free book of details.

### WHAT R.T.A. STUDENTS SAY

Norwood, Ohio  
I have connected with a large firm as Radio Service Manager and wish to extend my thanks for your help.  
Joseph Rapien, Jr.  
Yorkville, Ohio  
From Aug. 1 to Dec. 7, 1936, I repaired 163 radios and put up 43 aerials which is very good for part time work while studying your course.  
Chas. Koerber.

**RADIO TRAINING ASS'N OF AMERICA**  
Dept RC-79, 4525 RAVENSWOOD AVE., CHICAGO

Please Say That You Saw It in RADIO-CRAFT



# Sensational Value! DIRECT-COUPLED 10 WATT AMPLIFIER

designed by A. C. SHANEY

9<sup>68</sup>  
NET



**OPTIONAL ACCESSORIES:** Matched set of RCA or Sylvania Tubes, 2-6SJ7, 2-6L6G, 1-5U4G; \$3.59 . . . Tone Control, Condenser, Plate and Knob; 47c . . . Amplifier Cover \$1.25 . . . **OPTIONAL ACCESSORIES FOR TWIN CHANNEL OPERATION:** 2 Shielded Input Transformers (200-500 ohm) \$1.23 each . . . 2 Universal Output Transformers with feedback and compensating resistors and condensers \$1.20 each . . . 2 Volume Controls, Plates and Knobs 46c each . . . **OPTIONAL ACCESSORIES FOR PUSH PULL OPERATION:** Universal Output Transformer with feedback and compensating resistors and condensers \$1.50 . . . Shielded Input Transformer (200-500 high imp) \$1.35 . . . Twin Volume Control, Plate and Knob 94c.

**Outstanding . . .** this amplifier outperforms many commercial units selling from 3 to 5 times its cost. Thorough tests by A. C. Shaney, designer of this amplifier, prove that it fits all the conditions of an ideal amplifier, and leads by a wide margin the very finest resistance coupled, impedance coupled, or transformer coupled amplifiers.

Our new direct coupled amplifier, described in this issue, has many applications, such as: High-Fidelity P.A. Amplifier; High-Fidelity Phono Amplifier; Laboratory Standard Amplifier; For amplification in auditory perspective; For reproduction of artificial echo and reverberations, etc.

**COMPLETE ESSENTIAL KIT** as described in this issue (with instructions and diagram) **\$9<sup>68</sup>** net  
Factory Wiring and Testing \$1.95

**EXTREMELY SIMPLE TO CONSTRUCT**

Order direct from this ad

**AMPLIFIER CO. of AMERICA**

17 WEST 20th STREET NEW YORK, N. Y.

## USEFUL KINKS AND CIRCUITS

(Continued from page 31)

simply putting the screws in, the socket will align itself; and will fit socket holes that have odd distances between them. A neat job results, always, with no trouble.

I would like to see this passed on to the manufacturer; it would be no trouble for this type of socket to be put on the market and would be quite a help to us Servicemen.

ROY POWELL,  
Louisville, Ga.

Mr. Manufacturer:—How about it?—  
Editor

## MORE ON THE \$4,000 P.A. CONTEST

Many readers, judging from their letters, are under the impression that stories on rentals are not eligible in this great contest (See pg. 21 for details). This is definitely not so! Anyone—Serviceman, experimenter, engineer, etc.—is eligible to write-up rental installations that conform to the Contest rules.

Furthermore, if it is desired to keep confidential the names of customers for whom the sound installations were made (be these installations permanent, mobile or rentals), just so state when submitting your entry; and only the judges will see this information.

There is still time to win one of the many valuable prizes—\$1,000 worth given away each month.

## NEW!

A NEW GERNSBACK PUBLICATION

The Constructive Photo Magazine



ON ALL NEWSSTANDS

FOR serious-minded amateur photographers, here's a photo magazine, FOTO-CRAFT, vastly different from any you've read. It tells you how and why to do things—it's a constructive publication which shows what can be done with the equipment you have, and how to make handy, photographic accessories. FOTO-CRAFT, with its broad editorial features, covers such important branches of photography as—New Scientific Researches; Developing; Printing; Enlarging; Dodging; Cropping; Photomicrography; Color Photography; Amateur Movies; How to Make It Items.

A Few of the Articles in the Current Issue  
By such authorities as Herbert C. McKay; Mabel and Mario Seacherl; Dr. E. Bado; Leonard Hlyams; Carl Dial, etc., the titles include: Plenty to Photograph Right Under Your Nose—Soup Is Soup—It's All Greek; Alpha, Beta, Gamma, Delta—Photographic Designs Without a Camera—Noodle Titles—The Simplest Synchronizer Tester—Stereoscopic Table Tops—Home-made Synchronizing Flashgun—Silver Cabinet for Enlarging—Tomorrow's Photography—International Photo Digest—Table Top Photo Contest—Watch the Birds, Modern Style—Electric Photographs—Be Relieved Made by Treating Photographs—Movie Trick and Action Titles—Paper Negative Technique—Print It Yourself—Photo Hints and Kinks—What's New? Questions and Answers—Photo Quiz, etc.

**BIG OPPORTUNITY!!** Get a FOTO-CRAFT Press Card today—with it you can get permission to take photos which might be difficult to obtain. PRESS CARDS are sent FREE to subscribers of FOTO-CRAFT. Enter your subscription for Seven Months for \$1.00—and get your PRESS CARD immediately.

**FOTO-CRAFT**

99-R HUDSON STREET NEW YORK, N. Y.

## RADIO SERVICE PUZZLERS

(Continued from page 23)

still hear it—well you guess, I am afraid to tell you.

But a happy thought (and if it were not for this bright idea, you would not be reading about ph-zzz's). Using a vacuum-tube meter, with all tubes removed from radio receiver and the center-tap of the power transformer lifted, we were able to show a leakage of a few volts from one plate to ground—Finis. Yes, that solved the problem. Lucky—A happy thought!—Yes, but to what avail if we did not have the necessary test equipment as it was impossible to measure the small leakage with the average meter.

the aid of a high-range ohmmeter I found considerable leakage in the cotton insulated wiring of the grid and cathode circuits where it lay close to the chassis. After re-wiring the oscillator circuit with rubber-covered wire the set operated perfectly and has continued to do so.

Since that time I have found a number of cases of leakage with the aid of a V.-T.V.M. and high-range ohmmeter. These instruments are indispensable to me and in my opinion are necessities to the modern radio service shop.

## BELIEVE YOUR INSTRUMENTS

● The Radio: Belmont 8-tube set

This was a puzzler in every way, for every piece of service equipment was applied except an oscilloscope (which was not available at the time). Some of the most competent Servicemen had worked on the set without solving the problem. The strange thing about it was that everyone who worked on the set knew what was wrong, but no one could arrive at the cause.

The set was an 8-tube Belmont and the trouble was—oscillator frequency drift. When the set came to me every part in the oscillator circuit, with the exception of the tuning condenser, had been replaced. The set had been carefully realigned numerous times and in spite of all this the oscillator frequency would drift and stations would fade out and in. A signal from a test oscillator was fed into the circuit in place of the set's oscillator. When the set was tuned to a signal there was no fading. There was no doubt that the oscillator was drifting for all parts checked OK.

I believed my instruments, something the other Servicemen had not done. The components of the circuit were OK, so I reasoned that the I.F. transformers were so sharply tuned that a very slight oscillator drift would cause fading. The I.F. transformers peaked at 175 kc. I trimmed the primaries to 172.5 kc. and the secondaries to 177.5 kc., and the problem was solved.

## MOISTURE CAN BE TROUBLESOME

● The Radio: Philco Model 38

The Philco set was brought into the shop for repair. Preliminary examination indicated a defective oscillator circuit which failed below 800 kc. A complete check-up of all coils, condensers, and resistors associated with the oscillator failed to disclose any defects. After reducing the bias resistor, as advised in the manufacturer's service bulletin, the set performed perfectly for a short time.

Two weeks later the set was back with the same trouble. Further reduction of the bias resistor failed to produce the desired effect. The next day the set worked fine, much to my surprise, and continued to work all right on the bench. I released the set to the customer with a feeling that I had not seen the last of it.

Sure enough it was back in less than a week with an observation by the owner that "it seemed to fail after every thunderstorm." He seemed to think the lightning and static accompanying the storm caused trouble.

With this meteorological data it was only natural to assume that excessive humidity and not "static" was the real offender. The next step was to locate the moisture and its effect on the operation of the set. With

Please Say That You Saw It in RADIO-CRAFT



THE RADIO MONTH IN REVIEW

(Continued from page 7)

sort about you. You will have to remove it if you wish to go on," said the attendant. The young lady decided not to go on . . .

A house in Carteret, N. J., located a short distance from the transmitter of WOR in the same town, is a veritable shield can. And as a result of using sheet foil as the insulation of the house, it seems that only WOR can be received on radio sets inside the house, the station reported last month.

"The Human Earphone" is illustrated on pg. 7 (and on the cover of this issue of Radio-Craft)! You do not need any headphones, in this method of reception! The "trick" in this system of electrophonic reception is to apply a D.C. bias (V., in circuit on pg. 7) to the ear, via the electrodes described. Any experiments in this direction should be conducted with caution. In the photo, Dr. L. M. Harwich is the subject. (Photo, courtesy Dr. Stevens; data, Dr. Stevens, and Journal, Acoustical Society of America, Vol. 7, No. 3 and Vol. 10, No. 4.)

The research work in 1936 by Dr. Wilhelm Koenig, of the Museum of Bagdad, later supplemented by Khujut Rabu'a, in the southeast of Bagdad, has resulted in the discovery of the curious apparatus illustrated below. This strange device which was located in the region of Tel-Ourar has been placed as originating during the period of Kuehel of Ctesiphon, president of Bagdad, in the dynasty of the Sassanides, or about the years 224 to 651 A.D.! Examination of this strange device seems to indicate that it is an honest-to-goodness voltaic cell capable of delivering a small current at a little less than 2 V.!

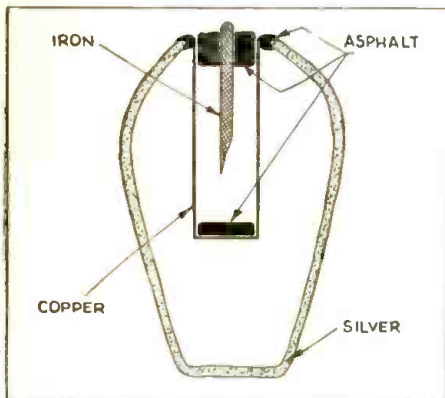

It is a vase of silver measuring about 6 ins. high and about 3 1/2 ins. in diameter with a circular opening about 3/8-in. in diameter. In the interior is a cylindrical tube about 4 1/2 ins. high and about 1/4-in. in diameter. At the base of this cylinder which is of copper is an asphalt button about 1/16-in. thick. The interior surface of the copper cylinder has at its neck an asphalt washer about 1/8-in. thick. The inside of the copper cylinder is traversed for nearly its full length by a second cylinder of iron about 3 ins. long and about 1/16-in. in diameter.

(The above is a literal translation by Radio-Craft of "Une Pile Electrique Datant de 2,000 Ans?" [literally, "A voltage source dating back 2,000 years?"], by Willey Ley, in a recent issue of La Nature [Paris, France]. It would be interesting to determine by careful chemical analysis what solution, or solutions, may have been used in this cell.—Editor)

Army Air Corps engineers at Wright Field report that it is entirely practical to install radio equipment in an airplane so

that the ship itself serves as an antenna. In this way frequent loss of a trailing wire antenna is eliminated; and so, too, is the need for de-icing.

A lightning storm which interrupted radio reception aboard a Douglas DC-3 of Eastern Airlines delayed landing and discharge of its passengers for an hour and 35 minutes, last month.

The "Riderless Bike," one of Westinghouse's many contributions of the marvels of Science to the New York World's Fair, steers with a precision no human can equal. You can take Radio-Craft's word for that—we were there! Light from an exciter lamp is reflected from a mirror (1, in photo, pg. 6) into a photocell located in the same box (2) with the exciter lamp (and amplifier). The mirror thus senses the least bit of tilting and transforms the light energy into electric current to control a regulating motor (3) which steers the wheel and moves the balancing weights. The strange-looking weight (4) over the front wheel is an "inertia sky-hook" to correct tilting, and the larger balancing weight (5) on the front mudguard acts like a balancing pole in the hands of a tight-wire acrobat. The coriolis anticipator (6) corrects tilting (even before the balancing weight can shift) owing to the gyroscopic torque which this "flywheel" develops. (The two vertical steel poles on either side of the bicycle only act as supports when the apparatus is at rest.) Left to right: Kirk A. Oplinger, Westinghouse Research engineer, shows Frank R. Kettering how this Phantocycle works.

"I christen thee 'Radiosonde,'" the U.S. Weather Bureau said last month in effect, when it threw into the discard the term, "radiometeorograph." This featherweight weather reporter which rides the rarefied airways of the stratosphere now has a more logical name.

The traveling radio repair shop, an American version of which was described several years ago in Radio-Craft, now helps Yugoslavites in their native country listen to American broadcasts. During a recent tour a Yugoslavian itinerant Serviceman attended to 300 radio sets in a total of 50 towns.

At the Building Exhibition in London, last month, a model flat included a sound-proofed air-conditioned "radio study," designed to enable the listener to indulge in late or early listening without disturbing his neighbors, Practical and Amateur Wire-les reported.

The royal road to success, insofar as N.B.C. is concerned, apparently stems from the job of Radio City guide and page. Stated President R. Lohr, in announcing a new personnel training plan for Radio City guides and pages, "Within 2 years we anticipate that every junior employee in this division will have a better working knowledge of broadcasting and we can plan to fill vacancies as they occur in the various departments and divisions of the company from the ranks of the junior employees in our training school."

The coin-operated radio receiver that created such a furore when it was first described in Science and Invention magazine in 1923, which at that time was owned and edited by Mr. Gernsback, who now owns and edits Radio-Craft, it seems became patent No. 2,152,903 in Rome, Italy, when it was granted to Domenico Mastini, last month.

(Continued on following page)

Please Say That You Saw It in RADIO-CRAFT

HERE IT IS... HAMS

A New AC and DC Pocket Volt-Ohm-Milliammeter



with Ranges to 5000 Volts—Self-contained.

Size: 3 1/16" x 5 3/8" x 2 1/8"

MODEL 666-H

\$14.50 Net Price

Will handle all Amateur Requirements

TRIPLET

DANGER

You must make high voltage tests—but you can't afford to take chances. Insist on the protection afforded by Triplet's complete insulation—molded panels and cases.

• A new Triplet AC and DC Pocket Volt-Ohm-Milliammeter that will handle voltages to 5000 volts without external multipliers. It will check the high voltages and circuits of transmitters and receivers—just the instrument for amateur use.

Ranges: AC-DC Voltage at 1000 Ohms per volt 0-10-50-250-1000-5000; DC Milli-ampers 0-10-100-500; Resistance 0-300 ohms shunt type 10 ohm reading at center scale; 0-250,000 ohms series type. 3700 ohms at center scale.

THERMO-AMMETERS

Prices greatly reduced. For a more efficient antennae circuit, investigate Triplet Thermo-Ammeters at your parts jobber.

Model 666—uses same case as 666-H. Reads to 1000 volts at 1000 ohms per volt. Net Price..... \$14.00

SEE THE NEW TRIPLET 1939-40 LINE AT THE JUNE NATIONAL RADIO PARTS TRADE SHOW—BOOTHS 403-405.

WRITE FOR CATALOG

The Triplet Electrical Instrument Co.  
167 Harmon Ave., Bluffton, Ohio

Please send me more information on  Model 666-H;  Model 666;  Thermo-Ammeters.

Name .....

Address .....

City ..... State .....

SOLAR gives you MORE for your money

MINICAP

Catalog upon request

SOLAR MFG. CORP., 599 Broadway, New York



# QUALITY—VALUE—GUARANTEE!

## WESTINGHOUSE POWER GENERATOR

Manufactured for U. S. Signal Corps

200 Watt.  
100 V. AC

### A. C. ELECTRICAL POWER

from a Windmill, from available Waterpower, from your Bicycle, Automobile, from your Motorcycle, from your Bicycle, Footpedals or Handcrank (for transportable Radio Transmitters, Strong Floodlights, Advertising Signs); operate two generators in series to get 200 V. AC; obtain two phase and three phase AC, etc., etc.

### There Are Over 25 Applications

Some of which are:  
A.C. Dynamo lighting from eight to ten 20 Watt 110 Volt lamps. Short Wave Transmitter supplying 110 Volts AC for operating "Ham" transmitter. Motor Generator, Public Address Systems, Electric Sirens on motor boats, yachts, etc. Camp Lighting, Short Wave artificial "fever" apparatus, Television, Pelton Waterwheel for lighting or other purposes, Airplane; for lighting strong search lights or electric signs, Laboratory work, etc., etc.

Generator, as described, including BLUE. PRINT 22 x 29 and Four-Page 8 1/2 x 12 in. INSTRUCTION SHEETS \$7.90  
Send \$2.00 deposit balance C.O.D. Shipping weight 18 lbs.

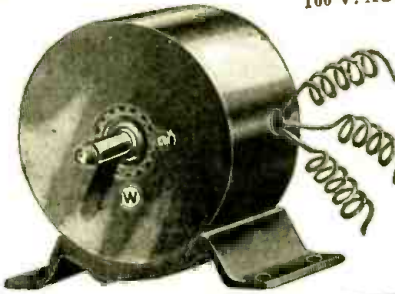

## PYRO PANTAGRAPH

Size of box: 12 1/2" x 8 1/2"



\$2.75

VOGUE

This electrical outfit is especially designed for burning leather, permanently on Leather, Wood, Cork, Gourds, Bake-plate, etc. Simply plug the Pyro-electric pencil in any 110-volt AC or DC outlet and it is ready to be used. Plug and cord furnished as part of equipment. By the use of a special Pantagraph included in the outfit, any design may be reproduced either in original, reduced or enlarged form. Outfit consists of: one Pyro-electric Pencil; one Pantagraph; Varnish; one bottle of; one tracing tip and four-page instruction sheet. \$2.75

SH. W. 3 LBS.

## G. E. PHONOGRAPH MOTOR

Formerly Sold for \$15.00

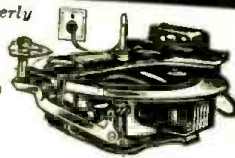

\$ ONLY 4.95

Variable speed induction type self-starting, 110 volt, 25 to 60 cycle, A.C. with speed control, plug and cord. Speed range from 5 to 200 R.P.M. Can be installed in place of old-fashioned, hand-winding speed motor. Also ideal for display turn table, and a hundred other uses. These General Electric Motors have never been used and come four packed in original carton. G. E. Electric Phonograph motor as described (with out turntable) \$4.95

Shipping Weight—12 lbs.

ALL OUR MERCHANDISE IS UNUSED AND SOLD ON A MONEY-BACK GUARANTEE

## MICROPHONE AND RECEIVER

This Microphone and telephone headset outfit was built especially for the U. S. Navy Aviation Corps. The outfit to Government specifications. The outfit consists of a low-impedance carbon microphone (transmitter), securely fastened to a metal breastplate, and a set of heavy-duty, low-impedance earphones. A specially constructed switch on the back of the breastplate controls the microphone circuit. The earphones are U.S.N. Utah type, attached to adjustable headband. Twenty-eight feet of very heavy weather and waterproof conductor cable is furnished. Current of not more than 10 volts should be used. A storage battery is the most satisfactory current supply.

U. S. Navy Airplane-type Microphone and Receiver as described \$4.96  
Shipping Weight—8 lbs.

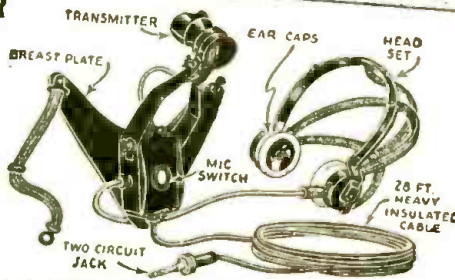

## WELLWORTH TRADING CO.

Dept. RC-739

1915 SOUTH STATE ST., CHICAGO, ILLINOIS

\* ORDER DIRECTLY FROM THIS ADVERTISEMENT \*

WE SHIP 24 HOURS AFTER RECEIPT OF YOUR ORDER, BY EXPRESS COLLECT OR PARCEL POST IF YOU INCLUDE SUFFICIENT POSTAGE.

300 WAYS TO MAKE MONEY

MAIL ORDER PLANS TESTED MONEY MAKERS BUSINESS SECRETS SUCCESS SCHEMES

25 CENTS

NATIONAL PLANS INSTITUTE, 246-R Fifth Ave., New York, N. Y.

## EXTRA Money For You

A Marvel Book 40,000 Words in Text!

In "CASH IN" you get ALL the real money-makers—dozens of profitable tested mail order plans, confidential business secrets, dozens of practical tested formulas, successful tested schemes—actual experiences of men who have started on a shoestring—with less than \$10 capital. Money-Back Guarantee.

"CASH IN" contains only tested ideas covering every type of full—or spare-time enterprise—it's a "master-piece" in business ventures.

25 CENTS per copy. Sent POSTPAID anywhere upon receipt of 25 cents U. S. stamps or coin.

## MORE SHORT WAVE

A pirate radio station of the Irish Republican Army is said to be broadcasting instructions to I.R.A. units on a frequency of 22 to 24 kc. in the hilly country near Killarney. The Government has direction finders on the job of locating it.

Radio-Craft takes this opportunity to extend its congratulations to the American Radio Relay League, now celebrating its Silver Jubilee. The A.R.R.L. has not merely had a ringside seat at the Radio Arena but in many cases has been an active participant in helping shape radio's path during the last quarter-century. Although the League was formed in 1914 it wasn't until 1915 that its official organ QST made its appearance. The League now has its own building in West Hartford, Conn., and a staff of 37. We also must not leave out mention of the new Hiram Percy Maxim Memorial Station which uses Mr. Maxim's old call letters, WIAW.

Here's one for our Thrill of a Lifetime department: Last month, Mr. Steve Lawrence, of Bethlehem, Pa., was tuning-in Budapest, Hungary, via short waves, on his Philco all-wave receiver, when the following message caused a tingling sensation to run up and down his spine.

"Attention, Bethlehem, Pennsylvania. Anyone hearing this message please notify Mrs. Barbara Nagy, 705 Linden Street, or her son William Nagy, 441 Broad Street, that her mother passed away March 6."

Mr. Lawrence immediately notified the Nagy family of their loss. This radio flash from Budapest was the only word the Nagy family had received on the death of Mrs. Nagy's mother.

## MORE TELEVISION

Just how good is a television image?

The New York Times has said, in a comment on the televised dedication ceremonies of the RCA Building at the New York World's Fair of 1939, that "every detail was distinct, even the fleecy texture of the clouds." The Daily Mirror reported "a clarity and precision which compared favorably with motion pictures." (See pix, pg. 7. Ed.)

These are eye-witness reports of the National Broadcasting Company's television relay over a distance of 8 miles from Flushing, Long Island. Thousands of Americans, however, have judged the technical quality of television's images by reproductions published in newspapers and magazines. They must have wondered at the discrepancy between the word description and the published photograph. Why does photography lose so much of the television image's detail and brilliance?

In the first place, the camera must be brought much closer to the television screen than the normal viewing distance in order to obtain enough light on the film, according to William Haussler, N.B.C. photographer, who has made more image pictures than any other photographer in the United States. This brings out the image's line structure, which is not visible to the eye when the image is viewed at the correct distance.

Furthermore, to obtain a reasonably clear picture the film must be exposed longer than 1/30 of a second, which is the duration of one complete television image. Thus, the camera catches a portion of two or more images and if the subject is in motion the photograph will be slightly blurred.

In the second place, both the eye and the camera are vastly more critical of a still picture than of one in motion. The eye sees the image in motion and consequently sees a clearer and more detailed "picture" than the

Please Say That You Saw It in RADIO-CRAFT



camera which, in effect, stops the movement and registers one or more "stills."

To make good image pictures—and at best they will be far inferior to the actual television image, says Haussler—it is usually necessary to catch the subject in comparative repose. Then the exposure is set at about 1/15th of a second—the duration of 2 complete images—and then the photographer crosses the fingers of his left hand for luck and snaps. ("Super-speed pan" is a good film to use. A leaf shutter is preferable.—Editor)

"History! Bloomingdale's Presents to America the First Public Fashion Show by

Television, Simultaneously Visible in 4 Places on Our 3rd Floor—Telecast From Our 6th-Floor Studio," read an ad, 10 ins. wide and 14 ins. high, in the New York Times, last month. The set-up was made in cooperation with the American Television Corp., and employed Kinets (C.-R. television receiving tubes in a housing) as the remote viewing units. The video camera was connected to the kinets by coaxial cable; accompanying sound included a running commentary on the fashions being modeled by mannikins.

This demonstration is of exceptional importance as a means of checking audience response to this type of program. We quote from the editorial columns of the Times:

"It is planned to install the 'kinets' at escalator landings and in various departments of the store to encourage multiple sales from customers who come with a fixed idea of what they want to buy. For example, while a woman is being fitted for shoes she can see the latest styles in dresses on the television screen and may be encouraged to buy one. The camera also has an attachment for film and therefore can transmit a continuous fashion show."

"I now look forward to the time, perhaps in the not-so-distant future, when we shall have stereoscopic television . . ." said Wilfrid Gartland, last month, in a letter to World-Radio (London, Eng.). Gartland's observation that "presumably" 2 channels would be required for the video or sight portion of the program, in order to achieve the desired stereoscopic effect, seemingly aroused the ire of one Arthur R. Coussens, whose comments, in a following issue of the same magazine, made interesting reading. Mr. Coussens suggested using the anaglyph

method and only one channel; and bi-colored viewing filters. (It seems to us that polaroid could be here used to advantage, in order to de-polarize at the receiver an image previously polarized at the transmitter, since this should make it possible to view the image in black-and-white.—Editor)

Gaumont-British Corp. hopes that by June theatre-size (12 x 15 ft.) projection-television equipment will be operating in about 2 or 3 Broadway theatres, according to general manager Arthur A. Lee, in a Times report. G.-E. has a controlling interest in Baird Pictures. In England, Gaumont is equipping about 150 of its 300 London theatres with similar apparatus. Lee sees telepix as a talkies-theatre 30-minute leader to draw in the crowd, considers tele-receivers too expensive, now, for the home, and believes that, eventually, the art will settle upon a "combination television and motion-picture show."

General Electric's New England television "net" is scheduled to start, with daily transmissions thereafter, July 1.

We quote Radio Daily of one day last month: "Initial experiments of televising in natural colors have been 'completed successfully,' by John L. Baird, English inventor, Isidore Ostrer, chairman of Gaumont-British, has cabled the American G.-B. office."

Paul Warburg and Angier Biddle Duke are reportedly backers of a million-dollar enterprise to install newsreel theatres in 15 major cities in the U.S., with all the theatres being designed and wired for television in the near future. Theatre No. 1 is going up in San Francisco.

Paramount Pictures, Broadcasting (magazine) reported last month, plans to "cash in" on the public's interest in television, and merchandise its products through television trailer-films, using Allen B. duMont's New Jersey transmitter.

Engineers of Allen B. Du Mont Labs. and Weston Electrical Instrument Co. last month told 400 Servicemen, who had managed to squeeze into the auditorium of the Electric & Gas Assoc. of New York, in the Grand Central Palace Bldg. (N.Y.C.), many things they wanted to know about television servicing and service equipment. (Radio-Craft's reporter came early to avoid the rush.) Among the many interesting facts presented was the one that the television receiver must be properly located in the home if best results are to be secured, and in selecting the location due consideration must be given to the relation of the cathode-ray receiving tube with respect to the Earth's magnetic field, which has an influence upon the cathode-ray beam. Another important point which was stressed was SAFETY.

Allen B. Du Mont Labs. last month filed application for 3 additional television transmitters. No. 1—A 50-watt mobile transmitter on 60-86 mc.; No. 2—A 1-kw. unit for 515 Madison Ave. (top floor), N.Y.C., on 60-86 mc.; No. 3—a 1-kw. unit for the National Press Bldg., Washington, D. C., on 42-56 mc. and 60-86 mc. The Passaic station, W2XVT, is scheduled to jump to 5 kw.

Harry R. Lubeke, No. 1 telly man of the Don Lee Broadcasting System whom Radio-Craft interviewed during one of his recent trips East, was the first speaker at the Television session of the Society of Motion Picture Engineers, last month. Lubeke told how he supervises programs through a conference telephone hook-up to his home!

Please Say That You Saw It in RADIO-CRAFT



**YOU WOULDN'T USE A TRAILER TRUCK TO TRANSPORT A TRUNK**

Just doesn't make sense . . . just as little as it makes sense to use a large resistor when a small Centralab Axial Lead Resistor will do the trick. It isn't size that counts . . . for most resistors in radio sets actually carry less than 1/4 watt load. High chassis temperatures and humidity cause breakdown . . . not moderate overload. That is why inserting a LARGE resistor is NOT the answer to a replacement problem.

Centralab Ceramic Resistors ARE the answer. Type 710 is conveniently small, yet fully insulated. Moderately rated at 1/2 watt it will carry normal overloads. Solid ceramic . . . humidity and temperature proof . . . priced so low you can well afford to keep a stock on hand.

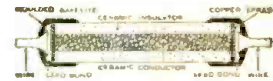

Type 710, rating 1/2 watt, size 1/8 x 3/16 inch. List price 60¢ for five.

Type 714, rating 1 watt, size 1/4 x 1 inch. List price \$1.00 for five.

See your jobber, or write for Bulletin 647

**Centralab**  
**AXIAL LEAD RESISTORS**  
DIVISION OF GLOBE UNION INC.  
MILWAUKEE, WIS.

- NEW MODEL 432
- CHECKS ALL TYPES RADIO RECEIVING TUBES
- COMPLETE SHOWING •
- 1939-40 Meters and Testers Booth 920 JUNE NATIONAL RADIO PARTS TRADE SHOW
- Write for Catalog—Section 716 College Dr.
- Tests New 1.5-, 35- and 50-volt Series, Local Base Types, OZ4 and Other Glass-tube Rectifiers.
  - Separate Plate Tests on Diodes and Rectifiers.
  - Neon Short and Leakage Tests.
  - Ballast Tube Continuity Tests.
  - Uses Attractive Trillium Direct Reading Instrument, 3" Size, (GOOD-BAD) Scale.
  - Line Voltage Adjustment.
  - New Improved Low Loss Switch.

**READRITE METER WORKS, Bluffton, Ohio**  
**RADIO ENGINEERING**

RCA Institutes offer an intensive course of high standard embracing all phases of Radio and Television. Practical training with modern equipment at New York and Chicago schools. Also specialized courses and Home Study Courses under "No obligation" plan. Catalog Dept. RC-39.

**RCA INSTITUTES, Inc.**  
A Radio Corporation of America Service  
75 Varlek St., New York 1154 Merchandise Mart, Chicago







connect the wobbler output to the Ant. and Gnd. posts of the receiver. Adjust receiver dial to the 2nd-harmonic of the I.F. peak frequency; for example 920 kc. setting of the receiver dial would be correct for a set peaked at 460 kc. With the wobbler band width set at 40 kc. turn the knob on the coil unit until the double image merges into one and looks like Fig. 8F. The knob should thereafter be left strictly alone until some other peak frequency is desired.

Now remove the wobbler connections from Ant. and Gnd. posts and reconnect from grid to chassis of the mixer tube. Turn the set control to high fidelity and see how close to Fig. 8E the receiver curve approaches. Incidentally the image may drift until the SYNC. control on the 'scope is set just so. If the image straddles as in Fig. 7A, adjust R2 until the slopes merge. The other adjustments were described in a previous paragraph. In order to gain some practice, you should deliberately throw the set out of alignment (I.F. only) and study carefully each effect as you re-align. In no time at all, you will get the hang of it, and be able to "go to town" on any alignment job.

The author will be glad to answer any questions on any point which is not perfectly clear to the reader. (Please enclose a stamped and return-addressed envelope.)

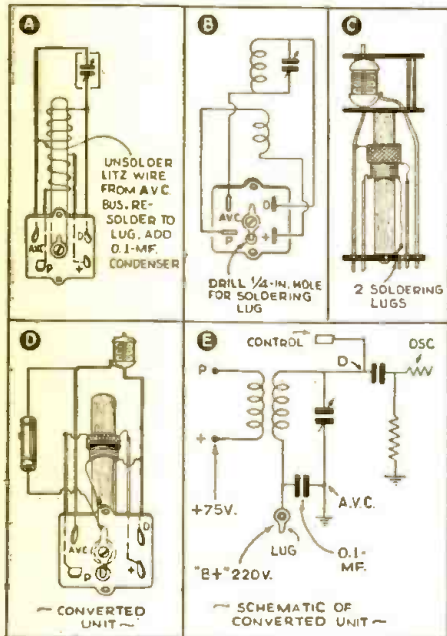

Fig. 12

**LIST OF PARTS**

- Two Kenyon power transformers, No. T-249, Pt.1, Pt.2;
- One Kenyon filter choke, No. T-156, Ch.1;

**CONDENSERS**

- One Cornell-Dubilier electrolytic, 8-8 mf., 450V., C1, C2;
- One Cornell-Dubilier electrolytic, 8 mf., 450V., C3;
- One Cornell-Dubilier electrolytic, 12 mf., 450V., C4;
- One Cornell-Dubilier electrolytic, 25 mf., 25V., C5;
- One Cornell-Dubilier electrolytic, 10 mf., 25V., C6;
- One Cornell-Dubilier tubular, 1 mf., 400V., C7;
- One Cornell-Dubilier tubular, 0.5-mf., 400V., C8;
- Three Cornell-Dubilier tubular, 0.1-mf., 400V., C9, C10, C11;
- One Cornell-Dubilier tubular, .01-.01 mf., 400V., C12;
- One Cornell-Dubilier bakelite-mica, 0.005-mf., C13;

N.U. Quality in Television Tubes carries on the enviable tradition National Union has established for quality in radio receiving tubes... High brilliance... Clean sharp focus... 441-line definition... constant sensitivity. And, of course, the new short stem requires less space for mounting and materially reduces breakage hazard. Just compare N.U. tubes for constancy in characteristics, performance and life.

If It's Shop or Test Equipment you need —WRITE N.U.

**NATIONAL UNION RADIO CORP.**  
NEWARK, N. J.  
SEE US AT BOOTHS 1012-1014, CHICAGO RADIO PARTS SHOW

- One Cornell-Dubilier bakelite-mica, 0.001-mf., C14;
- One Cornell-Dubilier bakelite-mica, 50 mmf., C15;
- One Cornell-Dubilier bakelite-mica, 5 mmf., C16;

**RESISTORS**

- One Centralab potentiometer, 25,000 ohms, R1;
- One Centralab potentiometer, 75,000 ohms, R2;
- One Centralab potentiometer, 2,000 ohms, R13;
- One Yaxley potentiometer, 450 ohms, R7;
- One International Resistance Co. wire-wound, 10,000 ohms, 5 W., R5;
- One International Resistance Co. wire-wound, 7,500 ohms, 5 W., R6;
- One International Resistance Co. wire-wound, 150 ohms, 5 W., R8;
- One International Resistance Co. insulated, 30,000 ohms, 1 W., R3;
- One International Resistance Co. insulated, 50,000 ohms, 1 W., R4;
- One International Resistance Co. insulated, 25,000 ohms, 1 W., R11;
- Three International Resistance Co. insulated, 1. meg., 1/2-W., R9, R10, R14;
- One International Resistance Co. insulated, 0.1-meg., 1/2-W., R12;
- One International Resistance Co. insulated, 50,000 ohms, 1/2-W., R15;
- One International Resistance Co. insulated, 7,000 ohms, 1/2-W., R16;

**TUBES**

- One Sylvania type 6X5 (rect.), V1;
- One Sylvania type 6J7 (freq. control), V2;
- One Sylvania type 6K8 (oscillator), V3;
- One Sylvania type 6K7 (sweep gen.), V4;

**MISCELLANEOUS**

- One dual ceramic trimmer, Meissner No. 22-7033, 35-120 mmf., C17;
- One B.F. oscillator coil, Meissner No. 17-6779, L1;
- Four octal wafer sockets;
- One Bud Radio, Inc. chassis, 7 x 11 x 2 inches;
- Tip-jacks, knobs, terminal strips, toggle switch, binding posts, grommets, hardware, etc.

**NEW... Short Length Television Tubes**

**A NATIONAL UNION DEVELOPMENT for all Builders of Television Sets and Kits**

Technical Data On Request to Engineers, Experimenters and Servicemen



**WHY SERVICEMEN INSIST ON N. U.**

Radio service engineers have learned over the years that National Union will never let them down. In quality, protection, price and dependability, National Union has proved it is the serviceman's tube, dedicated to helping servicemen "make more money."

**FREE TRIAL OFFER**

**NEW REMINGTON NOISELESS PORTABLE! AS LITTLE AS**



**10¢ A DAY**

Famous Remington Noiseless Portable that speaks in a whisper. Pay as little as 10¢ a day. Guaranteed by the factory. Standard keyboard. Automatic ribbon reverse. Variable line spacer and all the conveniences of the finest portable ever built. PLUS the NOISELESS feature. Act now. Send coupon TODAY for details.

**You don't RISK a Penny**

We send you Remington Noiseless Portable for 10 days' free trial. If not satisfied, send it back. We pay all shipping charges.

**Typing Course and Carrying Case**

You will receive FREE a complete simplified home course in Touch Typing, a handsome sturdy carrying case is included. No obligation. Mail coupon for full details—NOW.

Remington Rand, Inc., Dept. 189-7, 465 Washington St., Buffalo, N. Y.

Tell me, without obligation, how to get a Free Trial of a new Remington Noiseless Portable, including Carrying Case and Free Typing Course for as little as 10¢ a day. Send Catalogue.

Name .....  
Address .....  
City ..... State .....

**RADIO plus TELEVISION** -mastered by pre-tested Training

These growing trades need trained men—not "green" hands. Quality for good pay jobs with National's pre-tested training. Complete, modern facilities. Actual shop practice and studio instruction. Mail Coupon for FREE BOOK of details.

**NATIONAL SCHOOLS**

NATIONAL SCHOOLS, Dept. 7-RC, 4000 So. Figueroa St., Los Angeles, Calif. Please send free Radio and Television Booklet.

NAME ..... AGE .....  
ADDRESS .....  
CITY ..... STATE .....

Please Say That You Saw It in RADIO-CRAFT



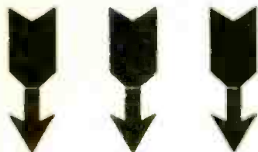

# The RSA Works for YOU, Mr. Serviceman!

## MAIL THIS COUPON!

RADIO SERVICEMEN OF AMERICA, INC.  
304 S. Dearborn St., Chicago, Ill.

Gentlemen:

I hereby make application for membership in the Radio Servicemen of America.

Name .....

Address .....

City ..... State .....

I am enclosing \$4.00 for Dues and Initiation.

(Does not include Local Chapter Dues where Local Chapters are organized.)

RC-739

★ Yes . . . the RSA is Yours! It's run by and for its members—uncontrolled by any outside interests. You elect your representatives (all responsible officers are bonded)—and they work for your benefit.

Here is what RSA gives you: ★ Advanced Circuit Notes for Members each month. ★ Technical Help on Service Problems. ★ Access to its National Speakers' Bureau. ★ Advanced Service Course to Members at slight cost. ★ A Monthly RSA Publication. ★ Annual Convention. ★ And many other benefits now being planned.

Take advantage of RSA activities. Send the Coupon Today—and be "in" with your fellow servicemen.

National Yearly Dues . . . \$3.00  
Initiation Fee . . . . . \$1.00



*Let's Grow Together in 1939!*

## RADIO SERVICEMEN OF AMERICA, INC.

Joe Marty, Jr., Executive Secretary ★ 304 S. Dearborn Street, Chicago

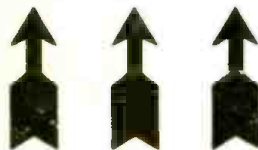

## SERVICING "COIN-OPERATED" PHONOGRAPHS

(Continued from page 22)

after long service and result in fluctuating input A.C. voltage to amplifier unless tightened.

### WURLITZER MODEL 616

This is a 16-record machine, 1937 model, and uses 2-30's, 4-45's and a 5Z3. The amplifier differs from the 412 model in that an extra 45 is used to furnish fixed-bias for the output 45's. (See schematic diagram, Fig. 1.) In addition to the complaints encountered in the model 412, the 616 is also subject to the following:

**Fading & Distortion:** This is caused by an open in one of the 4 wire-wound resistors comprising the fixed bias network. An open in either of the 2,000-ohm units or the 3,500-ohm unit will result in no bias on the output 45 tubes. The resultant high plate current causes the filament potential on the 30's to gradually diminish resulting in fading. An open in the 5,000-ohm unit will cause very high bias voltage on the output 45's resulting in weak or blocked signals. These resistors are all 10-watt and are located as follows: The two 2,000-ohm units are located near the type 30 tubes; the 5,000-ohm, near the output 45's; and, the 3,500-ohm, at the 5Z3. (See Fig. 2.)

Experience has shown it to be a good policy to replace all 4 resistors to avoid call-backs.

**No Sound:** Look for open primary in input driver transformer. Do not use an ordinary input for replacement as the primary must pass 40 ma. to feed the driver 45. In the event that an original is not available

a high-ratio input, such as the Freed No. 8133, can be used with parallel feed.

Input transformer failure is also common in the 412 model and the same procedure applies.

Examine pickup shorting switch (located near volume control) to see that contacts do not touch while machine is in playing position.

### WURLITZER MODEL 24

This is a 24-record machine, 1938 model, using 1-6C6, 1-76, 2-6L6's and a 5Z3. Common complaints are as follows:

**Blows 5Z3:** Caused by shorted 350-mmf. tubulars connected from 6L6 plates to ground. Owing to difficulty in getting a satisfactory replacement it is suggested that both these condensers be removed as they make no noticeable difference in the operation of the amplifier and are a frequent source of trouble.

**No Sound:** Look for open primary in input transformer. This transformer is driven from the 76 cathode, and voltages will appear normal unless measurements are taken from cathode and *not* ground. Look for resin joints at the eyelets near the apex of the speaker cone where the voice coil leads join the speaker cable.

### SEEBURG—ALL MODELS

**No Sound:** Look for open pickup coil.

**Weak:** Check pickup for off-centered armature.

**Fading:** Replace key-operated volume con-

trol. If an original is not available an excellent key-operated replacement can be made of an ordinary 10,000-ohm pot. by removing horseshoe washer where the shaft comes out of the bushing and proceeding as follows: cut off shaft about 1/16-in. from end of bushing and, using 2 hacksaw blades clamped together, cut a slot about 1/2-inch long into the shaft. Reassemble shaft into bushing, replace horseshoe washer, and install. (See Fig. 3.)

### MILLS DANCE MASTER AND DE LUXE

These are 12-record machines using 2-30's, 2-2A3's and a 5Z3. Common complaints are as follows:

**Distortion:** Check input transformer for leakage between primary and secondary. Check coupling condenser from 1st 30 plate to 2nd 30 grid for leakage.

**Hum:** Look for loose or broken ground connection at amplifier mounting bolt. Examine shielded cable from pickup to amplifier for break in shield.

### MILLS ZEPHYR

This is a 12-record machine, 1938 model, using 1-75, 1-76, 2-2A3's and a 5Z3. Distortion and low volume are often caused by a defective crystal cartridge in the tone arm. For a "no sound" complaint look for open speaker field.

**IMPORTANT: SEE PG. 21!** Win a \$225 sound-on-film recorder or a \$175 complete mobile P.A. system or a \$136 50-60 W. beam power amplifier, and many other useful prizes. It's easy; it's fun; it's educational. Turn to pg. 21 NOW for details.

Please Say That You Saw It in RADIO-CRAFT



## 4-STATION RADIO SYSTEM—PLUS TALK-BACK FEATURE

(Continued from page 29)

be purchased as required. It is color coded in exact accordance with standard telephone practice, and consists of 4 twisted pairs that have been specially wound for the elimination of transient pick-up and cross-talk (which is extremely prevalent in this type of work unless this type cable is used). With AMERCODE CABLE, 4 separate signals with levels as high as +25 to +30 decibels have been transmitted over several miles of the cable without appreciable cross-talk. In conjunction with AMERCODE CABLE, the talk-back units require a single shielded wire and a 2nd, 2-wire shielded cable is used for the signal system for controlling the on and off relay and pilot light.

During installation, if the house is under construction, it is a very simple matter to tack the AMERCODE CABLE and 2 shielded cables to the inside of the studs. The cable may be laid between the floors and even inserted in the plaster as it is waterproof. As the voltage never exceeds 8 or 10 volts there is no fire hazard and the installation will be accepted by the Underwriters. The openings for the room units may be placed wherever desired. Ample clearance is provided in the usual 4 inches between the

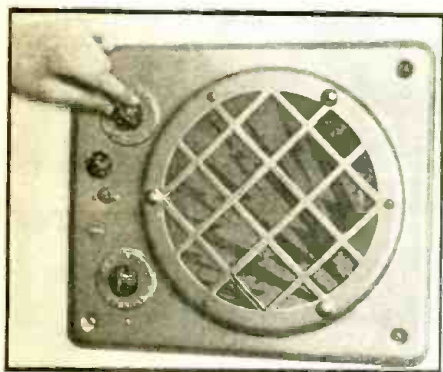

Close-up of one of the wall panels.

walls. It is good practice to use 2 x 2 in. pieces of wood for mounting strips on which to fasten the speaker units. When nailing such strips between the studs, remember to have the ends flush with the outside sections of the 4-in. studs. If possible line the entire inside of the speaker housing with rock-wool, ozite or similar sound absorbing material. (Be sure material is vermin proof!)

### START-STOP RELAY

Perhaps the most interesting part of this system is the *start and stop relay*. This device is of the ratchet type and operates merely by pushing the Start button on any of the room panels. Thus the system may be put into operation from any room and shut off from any room by pushing this button. A pilot light on each room panel, indicates when the system is in operation. A separate, 6 to 8 volt transformer is used for the pilot lights and, inasmuch as the pilot lamps are standard 14 volt elevator lamps, there is little likelihood that the lamps will ever burn out.

The volume controls are of the constant-impedance type and have been described previously by the author in *Radio-Craft*. In operation the impedance remains substantially the same regardless of the setting of the controls.

The power output from the average-size radio will usually be sufficient for this system. Of course the only consideration is the number of rooms to be supplied and also the size of these rooms and the volume that will be required. For the ordinary home of 5 or 6 rooms, 2 to 5 watts of undistorted audio power will be more than sufficient. However if more is available so much the better, but it will not be required unless the rooms are exceptionally large, or high volume levels desired.

*This article has been prepared from data supplied by courtesy of American Communications Corp.*

## NEW TUBE TESTERS

(Continued from page 19)

taps in place of the conventional single pie. Filament voltages from 1.5 to 50 volts are obtainable on one pie when the "HI-LO" toggle switch is thrown to the "LO" position. For filament voltages above 50 volts, the "HI-LO" switch is thrown to the "HI" position bringing into play the second pie on the Filament Vari-volt Selector Switch.

As a result, old man "Obsolescence" is dealt another knockout punch for these testers are now able to test any past, present or future tube type, not only regardless of its element terminations, but regardless of its filament voltage.

This is truly a forward step in tube tester design for it not only protects the user against obsolescence due to present 70- and 85-volt filaments but assures him that, no matter what the designed filament voltage, this tester will apply the correct potential across each filament.

These instruments check all receiving type tubes including all locals, 35, 50, 70 and 85 volt filaments, and all octal and non-octal types including television video amplifiers, single-ended types, tuning magic "eyes," ballasts, bantams, etc.

A speedy, roller chart lists all tube tests. A flick of the thumb brings you any desired tube type listing. From this chart radiate red "arrow-ways" which lead the operator from each listing to the proper controls on the panel.

Besides the newest addition, the FILA-

MENT VARIVOLT SELECTOR which correctly applies any desired filament voltage up to 110 volts, these testers offer the obsolescence-proof "Double Floating" filament return selector. This automatically correctly connects all filaments, heaters, cathodes and anodes regardless of tube base connections.

These testers check tubes 7 ways, as follows: (1) For open filaments, (2) a "hot" cathode leakage test, (3) a super-sensitive "hot" anode leakage test, (4) a short test between all elements, (5) a separate "open" element test, (6) an all-section quality test, and (7) a separate section quality test for multi-section tubes and separate plate tests for full-wave rectifiers.

A very helpful feature is the special pilot light socket which tests all pilot lights, flash light bulbs, Christmas tree lights, etc.

No line rheostat or separate line meter is used on these instruments. They use a multi-tapped transformer primary, tapped from 98 to 130 volts and automatically matched to the line supply through the use of the regular tube tester meter.

The circuit includes a standard 200,000-ohm-sensitivity leakage test between cathode and heater, as well as a super-sensitive 2-megohm leakage test between all other elements.

*This article has been prepared from data supplied by courtesy of Supreme Instruments Corp.*

Please Say That You Saw It in RADIO-CRAFT

*What Fun on Vacation!*

**LAFAYETTE**  
5 TUBE 3-IN-1  
PORTABLE

ONLY \$22.60  
COMPLETE WITH BATTERIES

**Plays Anywhere—No Aerial!**

Take along Lafayette's Portable "Pal" on your vacation. Wherever you are—at the beach, picnic grounds, in canoe or hotel room, on boat or train—just turn it on and tune it in! No aerial needed, no ground—no wires at all to fuss with. And when at home you can plug into the nearest electrical outlet (AC or DC). New built-in Lafayette Aeroscope pulls stations right out of the air. Ample volume, excellent tone. Smartly styled airplane-luggage DROP-FRONT case. Simply attach check or money order to coupon. Complete with tubes and batteries.

Send Coupon Today! Have Fun on Your Vacation

**SATISFACTION GUARANTEED!**

**LAFAYETTE**  
portable pal radio

RUSH YOUR CHECK OR A MONEY ORDER TODAY!

**LAFAYETTE RADIO CORP.**  
Division of WHOLESALE RADIO SERVICE CO., INC.  
Dept. 3G9—100 SIXTH AVE., NEW YORK, N. Y.

Enclosed is \$22.60. Please rush my "Portable Pal."  
CHECK  MONEY ORDER

NAME .....

ADDRESS .....

IF YOU PREFER YOU MAY SEND ORDER TO 901 W. JACKSON BLVD., CHICAGO, OR 265 PEACHTREE ST., ATLANTA, GA.

**MIDGET CONDENSERS That Do a WHALE of a BIG JOB!**

Want to save money on many of your condenser replacements? Want really good midget dry electrolytics—in really small sizes—at really rock-bottom prices? Then get next to Sprague ATOMS today. The fastest selling midgets on the market because they're the most reliable. Ask your jobber.

- ★ DUAL COMBINATIONS OR SINGLES
- ★ ALL WORKING VOLTAGES
- ★ UNCONDITIONALLY GUARANTEED AGAINST BLOW-UPS
- ★ LOW LEAKAGE
- ★ QUICK BUILD-UP
- ★ HIGH SURGE VOLTAGE

Sprague Products Co., North Adams, Mass.

**SPRAGUE**  
**ATOMS**  
SAVE TIME - MONEY - SPACE



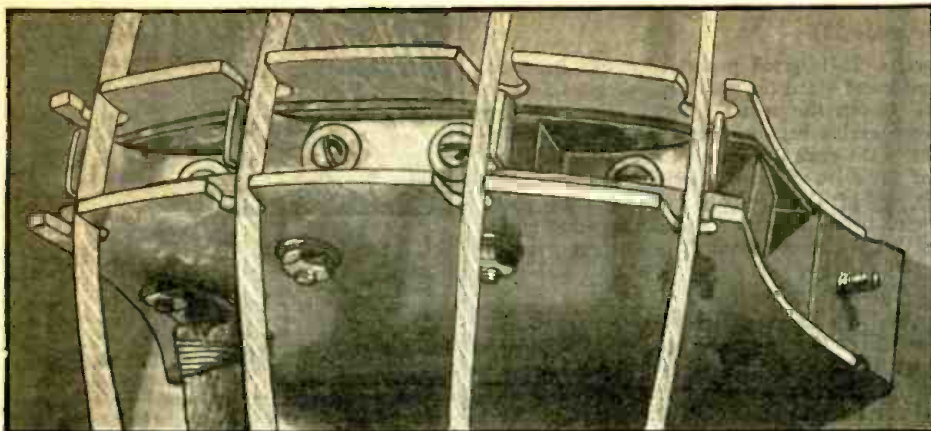

Close-up of the violin bridge; note relationship of the pickups to the gut strings which incidentally are "dusted" with a coat of Aquadag (colloidal graphite) to make them conductive.

## ANNOUNCING!—THE ELECTRO-ORCHESTRA

(Continued from page 14)

### REMOTE CONDUCTING

In this system, the microphone and the separate loudspeakers may be dispensed with and the electrical outputs of these instruments, via the conductor's control unit, sent on directly to the broadcast or recording system. It then becomes possible for the conductor to give vocal instruction directly through the air to his musicians, without having this get into the transmission channel along with the music!

Also other ordinarily disturbing studio noises, reverberation, etc., are kept out of the broadcast system. The musicians and the conductor can hear the conductor-monitored music through a monitor loudspeaker directly in their studio. Further, the various musicians can hear their own instruments alone through a head-telephone at whatever level above the monitor speaker's level that they may wish to adjust this by use of a control knob on the preamplifier for their instrument.

Where a studio audience is in attendance, the orchestra may be located within a glassed separating partition, and this studio audience is provided with loudspeakers so that they also hear the music just as the radio audience does. But this glass separation is only necessary to prevent this studio audience from hearing the conductor's vocal directions. It may well be that such an audience would prefer to hear these vocal directions along with the music just as they would at a rehearsal, and if this be the case the glass partition can be omitted, the audience then hearing the music from the same monitoring speakers used by the orchestra.

### MODERN ELECTRO-MUSIC INSTRUMENTS

I and my laboratory staff have been developing many types of electronic music instruments for over 8 years continuously and at an expenditure of about \$200,000.

Among these instruments are electronic pianos, organs, and combined piano-organs capable of a great variety of tonal effects and a wide dynamic range. Some of these and others are already being marketed under such names as the Hammond Organ, Novachord, Everett Orgatron, Electronic Pianos by Hardman-Peck, Ansley, Krakauer, Story & Clark and others, electronic guitars, violins, cellos, basses, chimes, etc. We have developed a number of other types; among these are (See "Recent Developments in Electronic Music," April, 1938, *Radio-Craft*):

- (a) A 13-toned chromatic kettle drum in the space of one conventional kettle drum—and having variable tone quality.
- (b) Clarinet with an electrical stop control for imitating also all the other orchestral wind instruments, one at a time.

- (c) Piano-organ which produces all types of percussive, plucked string, and wind instrument tones all obtained by completely pianistic playing technique giving *piano* to *forte* dynamic control of every tone (even organ), damper sustaining, and pedal swell control (see January, 1939, *Electronics* magazine).
- (d) All bowed string instruments of widely variable tone quality.
- (e) Brasses of variable tone quality.
- (f) Harmonicas with pipe organ tones.
- (g) Other wholly new instruments.

To weld all of these new instruments into a closely unified orchestra I have worked out a wholly new plan, which is made possible only by these new instruments. This is especially suited to broadcasting, recording, and public address augmentation as now so widely used.

### ORCHESTRA SYSTEM NO. 2

Although my first plan plus these above variations solves some of the age-old problems of orchestra technique such as by the use of new, variable-tone-quality instruments, the conductor's electrical monitoring and balancing and conductor's vocal directions still leave unsolved many other old problems of equal importance.

For the solution of all these problems I now propose a new orchestral system which embodies some of the features of the above plan together with several more advanced ones. It is believed that this system will completely revolutionize the technique of orchestral music interpretation, and probably of its composition as well.

This plan utilizes not only the new electronic instruments but also a new system of unification and direction, both achieved by electronic technique.

*In this plan the microphone is eliminated, since the electronic instruments all develop their tones as alternating currents, and are practically devoid of any direct acoustic tone output!*

All instruments connect to a Director's Control Unit and he sets the balance between them, varies this as the music may require, and operates an overall dynamic monitoring control (as by a foot swell), thus taking that last-mentioned operation out of the hand of the present monitoring studio engineer.

Each player retains full dynamic and timbre control of his own instrument, the former by direct playing manipulation plus added electric foot swell control, the latter by stops such as those used on an organ, by which his instrument may be made to assume any one of a variety of tones including its conventional type. But over and above these controls the director has the

previously-mentioned dynamic control both as to individual instruments, for balance manipulation, and as to a mass dynamic control, for overall dynamic effects.

Each player as well as the conductor may hear his music through a pair of headphones and each of these 2 phones has separate connections. One earphone of each player's headphones is connected directly to the pre-amplifier control box for his own instrument. Each of these has a control knob which allows the player to adjust the tone power of his own instrument in this earphone, the better to hear and to govern his own performance; but this knob does not affect the tone power of his instrument as passed along to the conductor's control unit. From this conductor's control unit the combined currents of all instruments go direct to the broadcast, recording, or public address system circuits.

### "PERSONAL" DIRECTING

The other earphone of each player and the conductor is connected to a 1-way telephone system whose microphone, such as a lapel type, is used by the director. Through this the director conveys most or all of his directions to his men, such as tempo, dynamic nuances, and any and all instructions to the group as a whole, to separate sections, or to individual players. He need use no visual signals, and the players can keep their eyes constantly on their music. Through this earphone each player and the director also hear the rest of the orchestra, with the director's monitoring included, and just as it goes on to the broadcast channels.

This system of Personal Direction is illustrated in the block diagram on page 14; the headphones had not been installed permanently, however, when the photo was taken.

Note therefore that each player wears a pair of headphones. The left ear, let us say, hears his own instrument alone and at a tone power which he can adjust sufficiently higher than that of the ensemble to enable him to hear it properly.

Through his right ear he hears the rest of the orchestra along with the conductor's oral directions; the orchestra ensemble which he hears in the right ear has been balanced and monitored by the conductor; so he hears the entire ensemble (even including his own as a part of this) in this right ear, exactly as the broadcast or other listeners hear it. The currents for this ensemble are fed from the output of the conductor's control unit directly into the 1-way telephone system, into which the director's microphone also feeds. This system feeds all the right-hand earphones of all the players as well as both the earphones of the conductor, who thus hears the ensemble, together with his own superposed voice; but only the ensemble music, with his vocal instructions omitted therefrom, is passed along to the radio or other transmission system.

### NOISE-PROOF ORCHESTRA

In its operation this direction system duplicates what is done in rehearsals by direct vocal instruction. But none of these verbal direction signals reach the broadcast or other circuits, since they are carried through this entirely separate, 1-way telephone system. Furthermore, microphone distortions as well as studio sounds and reverberations or noises are excluded from the music transmission system, as no music mike is used.

*Falling music racks, squeaking chairs, shuffling feet, coughing, etc., are all kept out of the broadcast. The players may tap their feet, talk to one another, etc., at will, and without interfering with the music! If reverberation effects or other sounds are*



desired these may be added electrically as now done in broadcasting.

There are many other advantages in such a system. The whole orchestra is immensely more unified, as each player hears all instruments other than his own equally loud; the distances between, or individual tone powers of, the different instruments affect this not at all; the flute player has no brass section blaring in his ears, and he can hear the distant string basses, violins, or harp just as well as the particular instruments immediately next to him; and so with all the others. At present the director cannot possibly know how the orchestra sounds to the broadcast or other listener or what the engineer-monitor in the glassed-in control booth is doing to his performance. He cannot now even know what the balance is, because the microphone is rarely close to him. A very large orchestra may, by such a system, be made as unified as a string quartet if indeed not more so. *There are no technical obstacles standing in the way of the immediate realization of such an orchestra.*

It is believed that this orchestra system will overcome the many grave obstacles to perfect performances confronting, for all these past centuries, the conventional orchestral system. The director has, in effect, each and every performer's ear just as if all of them were at his elbow.

He can count out the tempo, tell each one when to come in, and give them any other instruction by word of mouth; he can make any soloist or section stand out or down dynamically above the others by his individual-instrument supervisory control

knobs; he can, with his pedal swell, control the tonal dynamics of the whole orchestra from the faintest *pianissimo* up to the greatest *fortissimo*; his direction will thus be tremendously more complete than at present, and correspondingly more important and effective. Instead of being, as he is only too often, a mere figurehead or human metronome, he will be the real master of his orchestra at every moment.

**THE FUTURE**

A wholly new orchestral technique will grow out of these developments, bound as they are by no physical limitations; the instruments themselves, freed of their traditional, fixed, tone-quality limitations, can assume any one of a great variety of old orchestral and many entirely new tone qualities.

To conclude: Existing orchestral literature can thus be performed with tremendous improvement; composers will be given an entirely new and truly unlimited tonal palette and dynamics; conductors' control will be intimate and complete so that his orchestra will perform as one instrument; the musical horizons will be vastly extended, and our orchestral ideals realized.

(Of importance to musicians, and those who hire musicians, is the fact that Electronic Music of the type described here is in no sense *mechanical* music; and hence, for the reason that each instrument requires its own player, it has received the endorsement of musicians' unions—which see in Electronic Music almost limitless opportunities for employment.—*Editor*)

**TUNING WITH A RHEOSTAT!**

(Continued from page 13)

the iron core was inserted.

The outfit shown has been designed for the reception of ultra-short waves, received on a dipole antenna, in the range from 9.6 to 10.2 meters. The experimenter, however, may wish to utilize the principle, here described, to tune over a more limited frequency range in the broadcast band.

A close-up of the complete electromagnetic coil unit is shown in Fig. 2; at A, pictorially, and at B, by diagram.

In the ultra-shortwave autodyne circuit shown in Fig. 1, condenser C1 controls circuit oscillation. This condenser needs no further control after its initial adjustment, since the "tickler coil" as well as the "tank coil" (secondary winding) change their value of inductance in the same degree by the influence of the magnet field. Condenser C2 determines the operating range.

In Fig. 3 we see 3 condensers. The two added ones, C2b, C2c, are connected at will in parallel to condenser C2a by means of two relays which are operated by means of remote switches, Sw. 1a, Sw. 1b. The variable resistors R1, R2, are connected with a separate battery in order to simplify the diagram, and are used to vary the current which is sent through the turns of the "electromagnet." Roof and apartment units are connected by a cable. The I.F. output of the roof unit is fed by means of an I.F. transformer into the remainder of the superhet. This more perfected circuit is seen to employ a full-fledged converter tube, V, in the roof unit. Considering the fact that no complicated parts are required to construct this remote control unit one may expect that this valuable tuning method will become a great favorite with short-wave amateurs, to whom man-made static is a real bugaboo.

(For students interested in these effects we should like to call attention to the more

explicit paper published by Professor Leit-häuser, and the author in the *Funktechnische Monatshefte*. See, also, several other interesting articles, on this topic, in the same magazine.

(We suggest that television interests look into the possibilities of this scheme as a means of mitigating existing interference conditions, in the ultra-shortwave region, that are manifested on the video image screen as "snowstorms."—*Editor*)

**Feature Articles in the Special July Television Number of "RADIO & TELEVISION"**

- Mechanical Scanning—William H. Priess.
- Solving Television Program Problems—Thomas H. Hutchinson, N.B.C.
- Television Power Supplies, R.F. and Video Stages—Television Course—Henry Townsend.
- Making Dollars from Diathermy.
- Building a Television Receiver.
- I-Tube Television "Sound" Converter.
- Ham Transmitter Construction—Howard McEntee, W2FHP.
- Best S.-W. Station Time Schedule.

**it costs no more to test 50-75-100 volt tubes**

**MODEL 308 TUBE TESTER**  
Here's another big RCP value for the serviceman! RCP's new Model 308 tube tester is designed to test all the newest tubes, including the 50-75-100 volt filament jobs, as well as locals, single ends, OZ4, and other cold cathode rectifiers. Noise test. Hot interelement short and leakage check. Line voltage indicator on meter. And best of all, this new 308 instrument costs no more than former RCP testers, and less than other obsolete tube testers. See Model 308 at your jobber's today, or write for free catalog that tells the complete story. **\$16<sup>95</sup>**



**MODEL 701 SIGNAL GENERATOR**  
Now at new reduced prices — RCP's Model 701 Signal Generator. Direct reading, full vision AC all wave, 400 cycle sine wave modulation. Provides for unmodulated and externally modulated signal. Coil, attenuator and R. F. circuits individually triple shielded. Continuously variable from 25 kc. to 90 mc. **\$25<sup>95</sup>**  
**NEW ELECTRIC MULTITESTER!**  
See your local RCP jobber or write for details on the new Electronic Model 660 vacuum tube volt-ohmmeter. Tests 0.1 ohm to 1,000 megohms and up to 5,000 volts.



**RADIO CITY Products Co.**  
88 PARK PLACE NEW YORK CITY

**Better RESISTORS**

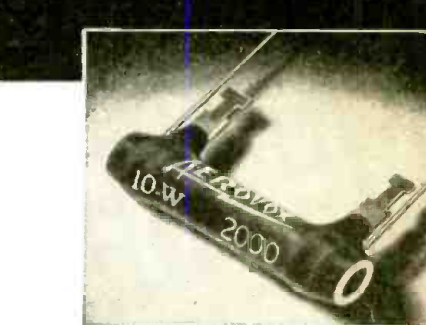

• AEROVOX wire-wound power resistors are fit companions indeed for AEROVOX condensers. There are the Pyrohm Jr. 10 and 20 watt fixed resistors. There's the Slideohm line of adjustable resistors in 25 to 200 watt ratings. • Your AEROVOX jobber can show you these superior power resistors. Also molded carbon and lacquered carbon resistors. • Ask for catalog—or write us direct.

**AEROVOX CORPORATION**  
NEW BEDFORD, MASS.  
IN CANADA: AEROVOX CANADA, Limited, Hamilton, Ont.



# RADIO MEN . . . HERE IS THE BEST REFRIGERATION SERVICE MANUAL EVER PUBLISHED - -

The OFFICIAL REFRIGERATION SERVICE MANUAL has been prepared so that it gives comprehensive technical information on servicing in this growing refrigeration industry. It contains detailed material on servicing; outlines of theory and methods of operation; instructions for the handling of refrigerants; charging systems; diagnosing troubles; trouble charts; electrical hookups; charges of oil and refrigerant in different models; advice on the selection of oils; placement and temperature required by foods; valve settings; compressor construction, faults, overhauling; estimating coil and machine loads; are encompassed in this volume on refrigeration servicing.

Here is the contents of the Official Refrigeration Service Manual

- |                                     |                                   |                                      |
|-------------------------------------|-----------------------------------|--------------------------------------|
| History                             | Low Side Float Valve Systems;     | Charging Systems with Refrigerant    |
| Food Preservation                   | High Side Float Valve Systems;    | Electrical Service; Motors, Fuses,   |
| Theory and Fundamental Laws         | Expansion Valve Systems; Therm-   | Hookups                              |
| Methods of Refrigeration            | ostatic Valve Systems; Restrictor | Estimating Refrigeration Loads, Coil |
| Refrigerants, Lubricants and Brines | and Capillary Tube Systems        | and Machine Sizes                    |
| Handling, Testing and Storage of    |                                   |                                      |
| Refrigerants                        |                                   |                                      |
| Compression System of Refrigeration |                                   |                                      |
| Liquid Throttle Devices and Valves  |                                   |                                      |
| Refrigeration Systems               |                                   |                                      |
| Electric Control Devices            |                                   |                                      |
| Compressors, Types, Seals, Valves,  |                                   |                                      |
| Capacities, Service                 |                                   |                                      |
| Evaporators and Cooling Units       |                                   |                                      |
| Service Tools, Equipment and Tool   |                                   |                                      |
| Manipulation                        |                                   |                                      |
| Commercial Unit Specifications and  |                                   |                                      |
| Service                             |                                   |                                      |
| Household Unit Specifications and   |                                   |                                      |
| Service                             |                                   |                                      |
| Servicing Refrigeration Apparatus:  |                                   |                                      |

OVER 352 PAGES  
OVER 300 DIAGRAMS  
Flexible, Looseleaf Binder  
Complete Service Data

RAD-CRAFT PUBLICATIONS, INC.  
99 Hudson Street,  
New York, N. Y.

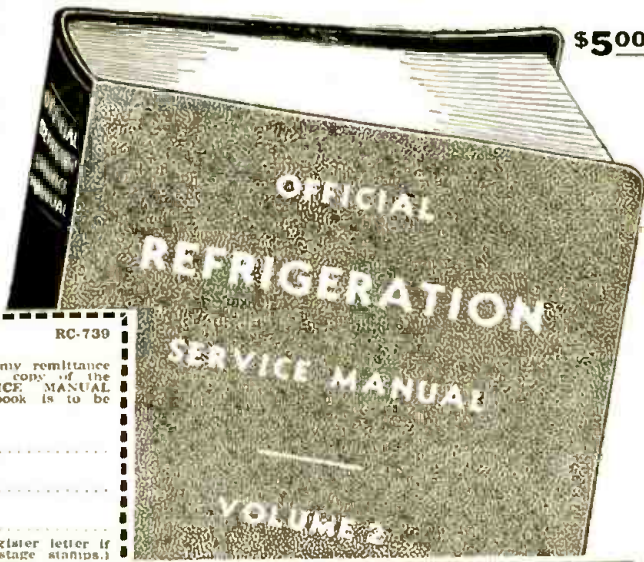

RAD-CRAFT PUBLICATIONS, INC. RC-739  
99 Hudson St., New York, N. Y.

Gentlemen:—Enclosed you will find my remittance of \$5.00, for which send me one copy of the OFFICIAL REFRIGERATION SERVICE MANUAL (Vol. 1). I understand that this book is to be shipped to me POSTAGE PREPAID.

Name .....

Address .....

City .. State ..  
(Remit by check or money order; register letter if you send cash or unused U. S. postage stamps.)

**Radio Men Find This Book Handy**

**FORMULAS AND RECIPES**  
For the Practical Man

**50¢ POSTPAID**

Here is the Contents of the Book

1. Adhesives: Glues, Cements, Gums, Mucilages, Lubricants.
2. Cleaning: Stain Removers, Paint Removers, Bleaches, Cleaning Fluids.
3. Metal Craft: Coloring, Oxidizing, Plating, Replating, Welding, Polishes, Alloys, Solders, Amalgams.
4. Paints: Colors, Stains, Varnishes, Enamels, Luminous Paint, Washable Paint, Paint-Removing, Waterproofing, Fireproofing.
5. Glass-Working: Cutting, Drilling, Boring, Bonding, Blowing, Etching, Engraving, Prastine, Silvering, etc.
6. Wood-craft: Fillers, Fireproofing, Acid-proofing, Waterproofing, Furniture Polishes, Finishes, etc.
7. Ink Recipes, Eradicators, Ink Stain Removers, Special Inks, Colored, In-Cellible, Sympathetic, Invisible, Hectograph.
8. Photography: Developers, Emulsions, Fixers, Sensitizing, Toning, Printing, Photographic Paper, Blueprint Paper.
9. Antidotes for Poisons, Remedies for Burns and Scalds, Disinfectants, First-Aid in Accidents, Emergency Remedies, Home Remedies.
10. Preparation, Manipulation, Handling, Mixing, Measuring, Weighing, Filtering, Straining Solutions; List of Technical Substances; Emulsifying; Use of Hydrometer, Use of Thermometer; Tables of Weights and Measures, Decimal Systems, Useful Tables.

**TECHNIFAX, Division RC-739**  
1917 S. State St., Chicago, Illinois

TECHNIFAX, Division RC-739  
1917 S. State St., Chicago, Illinois

Gentlemen: Enclosed please find 50c (check, money order, coin or unused U.S. stamps accepted) for which send me POSTAGE PREPAID, One Copy of FORMULAS AND RECIPES FOR THE PRACTICAL MAN.

Name .....

Address .....

City .. State ..

## AN I.F. TUNER FOR SERVICEMEN

(Continued from page 27)

such a simple test localizes your trouble. The final repair (even if it is primarily only a tube replacement) requires a turn-up of the chassis anyway to locate the trouble, precisely.

However the I.F. Tuner works nicely if needed especially for "intermittent" trouble. With the set under test tuned to a local broadcast station and the Tuner set to the required I.F. (located easily by a twist of its dial), and with its input connected to the 1st I.F. stage, a signal, if any, will be picked up and rectified, and the quality noted. If no signal is received the Tuner is set to about 550 kc. and connected to the input of the mixer (osc—1st-det.). The Tuner just reaches this frequency with the trimmers closed and if one has the choice of only one R.F. signal this is the one to tune in. Shorts in tuning condensers would most likely show up with the condensers fully meshed and the oscillator pretty nearly bound to oscillate if it oscillates here; besides, bypass effects of test leads are at a minimum at this broadcast frequency. Tapping in around 550 kc. from the R.F. stage or antenna winding should result in a good signal response from the test speaker. Thus we have found an input signal present and no output from the mixer. Should the trouble be intermittent in either of these stages it will be noted as such.

Localizing trouble in the I.F. stage is one of the simpler tests. If the set is at all sensitive, the finger tests definitely show up trouble if say a click is heard from the 2nd-detector and none from the I.F. stage. I.F. troubles are relatively simple to locate and the experienced man localizes them

easily. However the Tuner picks up their input and output signals when needed for an analysis. It is especially good for localizing noisy I.F. transformers and undoubtedly excels the "shorting out" method.

### THE SPECIAL TUNER

A description of the special Intermediate Frequency Tuner can most easily be given by saying it is a T.R.F. A.C.-D.C. receiver with the R.F. coils replaced by standard, replacement-type 456 kc. I.F. transformer.

Two are required and sell for about 35c apiece. Do not try adding turns to the old coils. This results in too much added capacity and reduces, considerably, the range of the tuner. In the writer's instrument the type 43 tube was replaced by a 6C6 tube for one R.F. stage. This reduction in plate current drain raised the plate voltage to about 150 volts. The speaker was also removed and a filter choke added. Since the input is untuned, only 2 tuning condensers are required. There is no reason why the unit complete, with audio amplifier, cannot be built from a junk A.C. set, if the builder prefers. The writer likes his audio channel separate; and besides, the idea of building the Tuner occurred to him while looking over a junk A.C.-D.C. set with speaker "shot."

The audio amplifier used is a 4-watt amplifier that can be fully driven by a low-level microphone. It uses one 6C6, into a 6C6 connected as a triode, into a 6V6 tube. If an A.C.-D.C. set is used the polarity of the A.C. cord must be observed in order to prevent hum and poor quality in the audio amplifier. The sensitivity of the Tuner is good, the finger acting as an effective antenna; and the selectivity is sufficient for the tests made. Errors due to the misalignment of sets show up on a calibrated dial when the set is tuned over its broadcast band and the I.F. signals picked off.

In conclusion let us not kid ourselves about our engineering skill on the repairing of the average radio. It has been the writer's experience that few men can turn up the bottom of a chassis and recognize what was in the back of the engineer's head when he designed it—and do so in a reasonable time. We may be service engineers when parked at home with our favorite radio magazine, but with the customer looking over our shoulder at his 16-tube supernoodledyne what we pray for is a simple idea to localize our trouble.

Radio sets are still made from the same components: condensers, resistors, and coils of wire connected together with more wire and with some tubes thrown in. They are still tested with fundamental instruments. While the more elaborate equipment is nice to have on hand especially to pursue our pet hobby, we will undoubtedly stick to the simpler instruments whenever we can in our daily work. The I.F. Tuner here described will undoubtedly come to be considered essential and to fill the requirement.

The writer's I.F. Tuner used "junk-box" parts. Tubes, though, were Sylvania; the 10-W., center-tapped and wire-wound resistor, Truvolt; and the I.F. coils, Carron 456 kc. "replacements."

Tube terminal voltages are given below. Use a 1,000 ohms/volt meter (250 V. scale); measure to ground. Line, 120 V.; volume control full-on.

Tube Type	Voltage Plate - S.-G.	Current (ma.) Plate - S.-G.
V1	145 12	1.8 0.2
V2	145 15	1.4 0.2
V3	60 15	.03 —
V4	147 —	— —

Please Say That You Saw It in RADIO-CRAFT



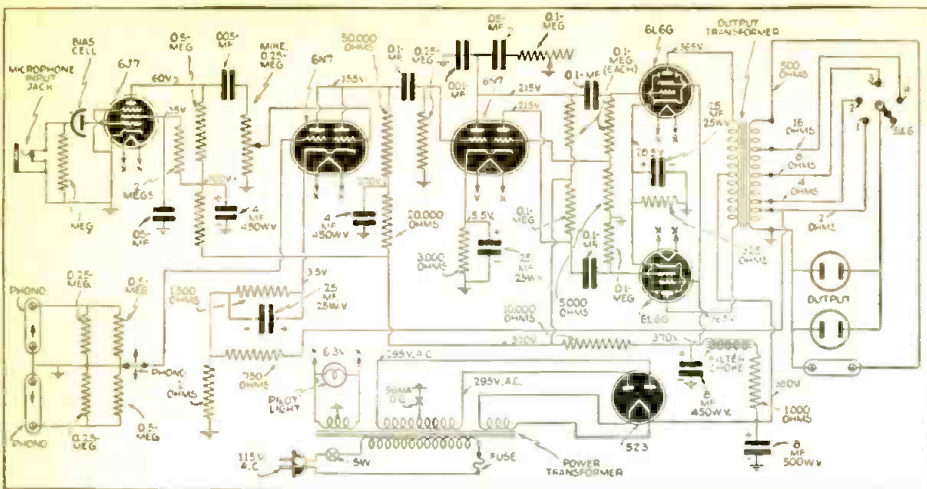

Fig. 3. Complete schematic diagram of a modern 18-W. public-address amplifier.

LATEST CIRCUIT FEATURES IN MODERN P.A. AMPLIFIERS

(Continued from page 20)

realized. This is the case in the circuit of the 12-watt amplifier illustrated in Fig. 2. To overcome this shortcoming when the microphone channels are employed, the series 1 megohm resistor is automatically reduced because the volume control employed is actually of the L-pad type.

**Inexpensive Negative-Feedback Circuit.** Referring back to the diagram of the 8-watt amplifier, you will notice that a somewhat different degenerative feedback circuit is employed. This circuit has the advantage of simplicity and offers better stabilizing action by actually reducing the impedance of the driver tube.

**Dual Phono Inputs.** Notice that in both circuits dual phono inputs are provided. The volume control for each of the circuits places an impedance of 500,000 ohms across the pickup used. However, an additional 100,000 ohm resistor is incorporated in parallel and will give optimum results when used with magnetic or crystal pickups.

**Bass Boosting.** If greater bass response is needed from crystal pickups, this resistor may be entirely removed or a higher value may be used in its place. In case the bass is to be accentuated when using magnetic pickups, the value of the 0.1-meg. resistor should be reduced to about 10,000 ohms. Different changes may be made in each of the two circuits to accommodate any requirements. These adjustments, of course, are independent of the tone control incorporated.

**Circuit-Grounding Jacks.** The 12-watt amplifier, as well as the 18-watt unit illustrated in Fig. 3, uses shorting-type microphone input jacks. This type of jack has the advantage of grounding the grid circuit in case a microphone plug is pulled out. This grounding is of considerable advantage in eliminating hum and noise pick-up when a channel not used is in the operating position because the volume control is not turned down all the way.

**Eliminating Cathode-Filament Leakage.** When high gain is used in the beginning of an amplifier, considerable difficulty may be encountered because of cathode to filament leakage. This may be entirely eliminated by keeping the cathode and filament at the same potential—connected together. In order to provide the needed negative bias on the control-grid if this type of circuit is used, a bias cell is placed in the grid circuit. The impedance of the cell to audio frequency is negligible. This feature is used in the circuits in Figs. 2 and 3.

It is interesting to note that the low-cost filter we describe next can be built more cheaply using 2 parts instead of 1!



18-W. De Luxe Amplifier.

**Low-Cost Filter.**

The plate voltage to the output type 6L6G tubes (Fig. 3) is obtained directly after the first filter condenser, but the screen-grid voltage for these tubes and the other potentials require additional filtering.

This is obtained by means of the choke connected in series with a 1,000-ohm resistor. The resistor serves to drop the voltage to a required value. Of course, a choke can be constructed to have the correct inductance and also the resistance required, so that the resistor need not be used, but the special design required in such a case would place the price of the choke out of proportion to its actual value.

**Flexible Negative-Feedback Circuit.** The inverse feedback is operated through 3 stages, giving better overall control. The circuit illustrated for obtaining the inverse feedback voltage gives considerable flexibility insofar as the phase of the voltage can be reversed by simply changing the plate connection of the 6L6G tubes to the output transformer, so that either 2 or 3 stages can be used in the feedback loop. The voltage produced by the output tap used is too large for the requirements and is reduced in a voltage divider circuit employing a 2-ohm and a 750-ohm resistor.

(To Be Continued)

This article has been prepared from data supplied by courtesy of Allied Radio Corp.

FIRST "HOME" TELEVISION?

The Milwaukee Journal company applied to the Federal Communications Commission for permission to inaugurate an experimental television service to the public. Stated the Commission: "The Journal Company's application is the first-application (italics ours—Ed.) looking to establishment of an experimental program service for reception in the home as distinguished from fundamental research or technical experimentation in the art of developing television apparatus. The Commission has previously issued a number of licenses for technical experimentation only."

In reply to inquiries by Radio-Craft the Journal advised, "We have made application to the Federal Communications Commission for a license to provide regular television program service rather than an experimental service."

*Everything in Radio*  
AT LOWEST PRICES!  
7 NEW PORTABLES  
★  
60 OTHER SETS

GET ALLIED'S SUMMER CATALOG  
Send coupon now for ALLIED'S Free Summer Catalog. 164 pages of radio values! Over 14,000 parts: Sound Systems, 8 to 65 watts, at new low prices; radio's biggest line of record players, phonographs, recorders; latest test equipment; new Amateur gear; dozens of Kits; books, tools, etc.—and 62 new Knight Sets, as low as \$5.95—all types; new portables \$10.95! Everything in radio at lowest prices, in ALLIED'S catalogue! FREE—send coupon!

ALLIED BOOKS 10c  
RADIO BUILDERS! P.A. MEN!  
"Radio Builder's Handbook"—For beginners, tells how to select circuits, read diagrams, make chassis, etc.—only 10c!  
"Essentials of Recording"—Complete facts, tips on making records, reproducing, etc.—only 10c, send coupon.

FREE CATALOG  
ALLIED Radio Corporation, Dept. 2-G-9, 833 W. Jackson Blvd., Chicago, Ill.  
 Send your Free Radio Catalog.  
 10c Enclosed. Send Builder's Handbook.  
 10c Enclosed. Send book on Recording.

Name \_\_\_\_\_  
Address \_\_\_\_\_

YOU CAN BECOME A MONEY-MAKING RADIO EXPERT WITH THE New **SPRAYBERRY** Personalized HOME TRAINING in RADIO and TELEVISION

You Learn Easily in Your Spare Hours . . . .  
By Doing Many Experiments with Up-To-Date Equipment

Here's a really fine, up-to-the-minute Radio and Television Training that's specially designed to give you quick results. TRAINING PREPARES YOU FOR GOOD RADIO JOBS . . . AT EXCELLENT PAY. My training starts right at the beginning of Radio . . . unfolds each subject in a simplified, logical, understandable style. You easily learn: Television, Electronics, Facsimile Radio, Radio Set Repair and Installation Work, etc.

NO PREVIOUS EXPERIENCE NEEDED! It makes no difference what your education has been. I can fit you for a good-paying Radio job. Your success is my full responsibility.

YOU GET PROFESSIONAL TEST EQUIPMENT PLUS EXPERIMENTAL OUTFITS  
Includes 116 Radio Parts (to build complete Receiver), Tools, All-Wave, All-Purpose Analyzer, and Experimental Outfits for conducting actual experiments with your own hands.

**I Supply**  
My BUSINESS BUILDERS show you how to put your Equipment to practical use in handling actual money-making Radio Service jobs shortly, after you begin training.

**SERVICEMEN**  
I offer Advanced Training for those already in Radio. Get complete details in my FREE 52-page Book. The Sprayberry Course is Sold Under a Money-back Agreement.

RUSH COUPON for BIG FREE BOOK  
SPRAYBERRY ACADEMY OF RADIO  
F. L. Sprayberry, Pres., 220-G University Place, N. W., Washington, D. C.

Please send me FREE copy of "HOW TO MAKE MONEY IN RADIO."  
Name \_\_\_\_\_ AEC. . . .  
Address \_\_\_\_\_  
City \_\_\_\_\_ State \_\_\_\_\_  
Tear off this coupon, mail in envelope or paste on penny postcard. Servicemen—Check here

Please Say That You Saw It in RADIO-CRAFT



## A NEW SECONDARY EMISSION TUBE

(Continued from page 15)

### EMISSION-TUBE CONSTRUCTION

The construction of tubes for secondary emission is confronted with certain difficulties. The cathode always causes barium, or oxide of barium, or similar materials to evaporate. Experience has shown that cold cathodes quickly became inactive owing to deposits caused by this evaporation. This fact has led to the peculiar arrangement of electrodes shown in Fig. 1C. The bundle of electrons is diverted under the influence of a directed electric field and is led in a curve path from the glowing cathode to the anode or plate.

The bundle of electrons which leaves the glowing cathode K1 passes the meshes of the control-grid G1 and is accelerated by an auxiliary grid G2 which has a positive voltage. The two auxiliary electrodes s1 and s2, which are connected with the cathode potential, produce the directed electrical field, through which the bundle of electrons is directed towards the cold cathode by way

of an arch. A second acceleration grid G3 is placed about 1/2-mm. in front of the cold cathode. This grid has the same potential as the anode, but it is about 100 volts higher than the cold cathode K2. The electrons, the majority of which passes this wide-meshed grid, and thus are speeded up very much, hit the cold cathode and thereby produce secondary electrons. These secondary electrons can move freely, as the second auxiliary grid eliminates any charging of space which might otherwise have taken place. When they pass the auxiliary grid again, they are accelerated anew, and, finally, they land at the flat anode a.

The qualities of the tube make it especially valuable if used in a television set. (See Fig. 1E.) It may also be used as an oscillator. Due to the fact that a cold-cathode current flows, inside the tube, in a direction opposite to the anode-current flow, the tube is particularly suitable as a phase inverter.

The arrangement of the various parts in-

side the tube can be seen from the photo. The wiring of the socket can be seen from Fig. 1D.

### CHARACTERISTICS

#### Heating:

Filament voltage	6.3 V.
Heating current	0.6 A.

#### Capacities:

Cg1	0.004 mmf.
Cg1	10.00 mmf.
Ca	0.3 mmf.

### CHARACTERISTICS IF USED AS I.F. AMPLIFIER

Anode voltage	250 V.
Screen-grid voltage	150 V.
Secondary cathode voltage	150 V.
Anode current	8 ma.
Negative grid bias	-2.5 V.
Secondary cathode current	6 ma.
Screen-grid current	0.7 ma.
Slope	14.5 ma.-V.
Internal resistance	100,000 ohms

## HOW TO MAKE AN "IDEAL" ALL-PURPOSE PORTABLE

(Continued from page 12)

right-angles to form the riveting bracket. Drill 3 No. 30 drill holes on ends and center and corresponding holes on the phono-oscillator panel and folded end 2 1/2-ins. from the gang end of the panel and square to the folded side. Locate holes for the tone control switch 1 x 1 1/2 ins. from corner.

Fashion a gang condenser bracket from a piece of sheet steel 3/8 x 1 7/8 ins. Cut and bend the material at right-angles 5/8-in. to form the gang condenser bracket. Drill 5/16-in. hole for oscillator-padder. Drill 3 No. 30 holes in bent-up portion and locate on main chassis, drilling corresponding holes in chassis, and rivet same. Drill No. 26 hole in main chassis to mount spade lug on the back of the gang condenser, and remove the two spade lugs near the shaft end. Drill holes in gang-mounting bracket corresponding to holes on back of the gang.

From a piece of sheet steel 5/8 x 1 1/2 ins. bend into a right-angle a bracket to use as an "A"-battery bracket. This prevents the "A" batteries from engaging and injuring the motor mechanism.

### COMPONENTS

Although most of the components are easily located by the preceding paragraphs and the figures, in some instances it is necessary to revamp the following:

The radio oscillator coil shield must be mounted directly on top of the R.F. coil and mounted to the main chassis by means of a 1/8-in. rivet. A No. 30 drill is used for this hole in the top of the shield and main chassis.

The phono-oscillator coil shield must be cut off 1 1/4 ins. from the open end. The 50 mmf. condenser attached to the phono-oscillator coil bracket must be removed and replaced on the inner side of the terminal bracket. Also at this stage connect the R12, 10,000-ohm resistor across (or parallel to) the above condenser. Disregard the manufacturer's color coding on this coil, as it is used differently in this circuit.

The change-over switch must be bent on the side of the partition to clear it. The selector shaft is supplied long and may be cut off to the desired length. The same is true with the volume control shaft.

The crystal pickup drop-stop must be bent down enough to enable the head to rest upon the record. A shielded extension lead must

be added from the phono tip-jacks to reach the change-over switch.

The phono-motor must be grounded by means of shielded braid to the volume control ground lug. This is necessary to prevent audio feedback. The turntable brake must be bent upward and to one side to clear the dial.

There will be a comparatively shallow space in which to mount the speaker. Fitting it into this space is possible only by mounting the speaker on the front of the removable baffle board. This can be accomplished by the well-known "cut-and-try" system, making the cone edge fit flush with the baffle.

### ANTENNA

The loop antenna is constructed from a high Q standard R.F. wire. Thumbtacks were placed 6 x 10 1/2 ins. to form a rectangle. These form the center or start of winding, and as each successive layer is added, melt a good grade of R.F.-coil wax and brush at the corners to hold the wire in place firmly during the winding process. It is well to wind about 28 layers and coat them heavily with orange shellac. This does not materially affect the Q but it does provide a method of holding the loop firmly in place and fastening it securely to the case. Make the adjustment as listed under Instructions, and then solder the inside of the loop to the outside of the antenna connector, which has been mounted on the front of the hinged baffleboard. The outside of the loop, naturally, hooks to the inside of the connection.

### CABLES AND WIRING

The "A" supply and volume control cable contains 8 wires covered with a shielded braid and cotton serving. Attached to one end is an 8-pronged octal plug. An old tube base may be used for this. The socket is an 8-pronged octal tube socket mounted with spacers and wood-screws to the bottom of the motorboard. The 2-pronged speaker socket and speaker cable is so designed that a 25-foot rubber-molded (lamp cord) cable may be inserted for extension use. Tip-jacks are provided for the pickup cable.

As noted in schematic the filaments are connected in a unique series-parallel circuit. This represents economy of battery drain from the two little No. 6 drycells as the

individual tube drain is from 3 volts instead of 1 1/2 volts; thus increasing the battery "hours of service" curve. Then, too, one-half of the 3 volts is used as part of the output tube bias. You actually gain, however, about 2 volts to the center of the filament and to the "B" supply.

### INSTRUCTIONS

After all the constructional work is completed, align the receiver by first connecting a 175 kc. signal from an oscillator through a 0.1-mf. condenser to the 1A7G grid. Align in order the No. 2 and No. 1 I.F. trimmers. Then, with connections in same order, change the signal generator to a frequency of 1,650 kc. and, with the gang wide open, align the oscillator trimmer to the signal. Transfer the signal lead to the R.F. grid and align at 1,400 kc. the 1st-detector trimmer. Tune the oscillator and the gang condenser to the 600 kc. and align the padder by rocking the gang for maximum gain. Then re-align at 1,400 kc.

Remove the signal generator lead and tune as weak a station as is in the vicinity of 1,400 kc. Rotate the portable to maximum volume, and with the volume control on full, track the loop antenna—with loudspeaker in place (otherwise, inductance value of loop will be altered)—by removing the turns until the antenna trimmer trims properly. Make sure that the antenna trimmer is in track at the 600 kc. end. If the trimmer screw has to be loosened, this means too many loop turns; and if it is necessary to tighten, vice versa.

When operating the receiver in remote areas, it may be necessary to rotate the loop in the direction of the station for a maximum efficiency. Should you find a longer aerial necessary in remote areas, a single turn of wire wound next to the loop winding with one end connected to the aerial and the other to the ground will suffice.

A dial plate 2 x 2 ins. may be used, under which you may place a white piece of celluloid calibrated for facility in station location. This calibration may be made directly from stations of known frequency, or by using a 100 kc. signal. Drive is direct.

The main chassis may now be securely fastened by 4 small wooden blocks in each corner, held by a 1/2-in. wood-screw.

Cover the main chassis, which forms the record compartment and bumper, with felt, using rubber cement to hold it in place.



The phono-crank may be placed in the compartment above the phono-oscillator chassis when not in use. The phono-oscillator trimmer knob, incidentally, should be turned to a dead spot on the receiver dial for phono-oscillator operation. If the household receiver is insensitive it may be necessary to add the (A.C.-D.C.) type flexible wire antenna to phono-osc. tip-jack.

**CONCLUSION**

The combination described in detail above provides a maximum of types of entertainment at a minimum cost. Practical to construct, it is economical to operate, in that all the tubes are not in operation simultaneously. For instance, 1 tube only is used for "wireless" phono—3 tubes only for phono and P.A. use—5 tubes for radio use—etc.

Builders will save time, expense and headaches by using the parts used and recommended by the authors. In several cases, a substitution is impossible because of the limited space in the portable case.

**NOTES**

Switch Sw. 1, shown below in a close-up circuit, in conjunction with other switches selects the services, as follows:

**Sw. 1, position No. 1 (Phono-audio).** Set Sw. 3 in No. 2 pos. (pickup connection) for record use; or, in No. 1 pos. (microphone connection), and microphone plugged into jack on motorboard, for P.A. use.

**Sw. 1, position No. 2 (Radio).** Set Sw. 2 in No. 1 pos. for loudspeaker use; or, in No. 2 pos. for headphone use.

**Sw. 1, position No. 3 ("Wireless" Phono).** Set Sw. 3 in No. 2 pos. for record playing; or, No. 1 pos. for microphone use.

Condenser C18 is variable, but once adjusted does not require readjustment. C16, 350 mmf. (max.); trimmers C17, 20 mmf. (max., approx.); C19, 110 mmf. (max., approx.); and controlled by the "Wireless" Phono knob).

Designed in collaboration by the authors, the actual construction of the Ideal 6-Tube All-Purpose Battery Portable was made by Mr. Archenbronn; the completed unit was then shipped from Detroit to New York and there double-checked by Radio-Craft.

—Editor

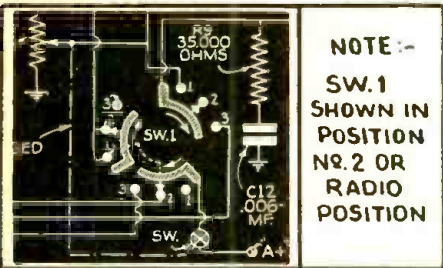

**NOTE:—  
SW.1  
SHOWN IN  
POSITION  
NO. 2 OR  
RADIO  
POSITION**

**LIST OF PARTS**

One Montgomery Ward Portable Phono-graph.

**COILS**

- One Meissner R.F. coil No. 14-1497, L2;
- One Meissner oscillator coil No. 14-4242, L3;
- One Meissner No. 1 I.F. coil No. 16-5728, I.F.T. 1;
- One Meissner No. 2 I.F. coil No. 16-5730, I.F.T. 2;
- One Meissner phono-osc. coil No. 17-9373, L4.

**RESISTORS**

- One Centralab resistor 0.1-meg., ¼-W., R1;
- One Centralab resistor, 70,000 ohm ¼-W., type 710, R2;
- Two Centralab resistors, 1 meg., ¼-W., type 710, R3, R4;

- Two Centralab resistors, 50,000 ohm ¼-W., type 710, R5, R14;
- Two Centralab resistors, 2 megs. ¼-W., type 710, R6, R7;
- One Centralab resistor, 0.5-meg., ¼-W., type 710, R8;
- One Centralab resistor, 35,000 ohm ¼-W., type 710, R9;
- One Centralab resistor, 30 ohm ¼-W., type 710, R10;
- One Centralab resistor, 10,000 ohm ¼-W., type 710, R12;
- One Centralab resistor, 0.2-meg., ¼-W., type 710, R13;
- One Centralab resistor, 20,000 ohms, ¼-W., type 710, R15.

**CONDENSERS**

- Three Cornell-Dubilier condensers, 0.05-mf., 400 V., No. DT-4S5 C1, C2, C3;
- One Cornell-Dubilier mica condenser, 250 mmf., No. 5 W-5T25 C4;
- Two Cornell-Dubilier mica condensers, 100 mmf., No. 5W-5T1 C5, C6;
- Two Cornell-Dubilier paper condensers, 0.01-mf., 400 V., No. DT-4S1 C7, C8;
- One Cornell-Dubilier electrolytic condenser, 10 mf., 25 V., No. BR102 C9;
- One Cornell-Dubilier paper condenser, 0.004-mf., 600 V., No. DT-6D4 C10;
- One Cornell-Dubilier paper condenser, 0.5-mf., 400 V., No. DT-4T5 C11;
- One Cornell-Dubilier paper condenser, 0.006-mf., 600 V., No. DT-6D6 C12, C15;
- One Cornell-Dubilier mica condenser, 50 mmf. (comes with phono-oscillator coil), C13;
- One Cornell-Dubilier paper condenser, 0.1-mf., 400 V., No. DT-4P1, C14.

**SWITCHES**

- One Mallory-Yaxley rotor switch, No. 1313L Sw. 1;
- Two Mallory-Yaxley S.P.D.T. switch, No. 11, Sw. 2, Sw. 3;
- One Mallory-Yaxley S.P.S.T. switch, No. 10, Sw. 4.

**TUBES**

- Two Sylvania type 1N5G tubes;
- Two Sylvania type 1A7G tubes;
- One Sylvania type 1C5G tube;
- One Sylvania type 1115G tube.

**MISCELLANEOUS**

- One Oxford-Tartak 6½-in. P.M. dynamic reproducer with 9,000-ohm (pri.) transformer, No. 6YMP T, T;
- One Meissner gang condenser, No. 21-5215;
- One Meissner oscillator padder, No. 22-7009, C20;
- Two Meissner bar knobs, No. 25-8,222;
- One Shure Bros. crystal pickup model, 94A;
- One Shure Bros. crystal microphone;
- One Brush Labs. high-fidelity crystal phones;
- One Mallory-Yaxley microphone plug, No. 75TC;
- One Mallory-Yaxley microphone jack, No. 701;
- One Centralab 0.5-meg. volume control, with switch No. P-103 R-Sw.;
- Five Mallory-Yaxley tip-jacks for headphones, and pickup connection No. 419;
- Two Mallory-Yaxley tip-plugs for pickup, No. 415;
- Seven Meissner octal sockets No. 25-8209;
- Two Burgess "B" batteries No. Z30NX;
- Two Burgess "A" batteries No. 4FA;
- One piece of felt 10 x 15 ins.;
- One assortment of hardware, hook-up wire, cable, battery terminal lugs, ¼" x ¼" rivets, and celluloid for dial;
- One hank of (A.C.-D.C. type) flexible antenna wire for phono-osc. antenna, L5.

Please Say That You Saw It in RADIO-CRAFT

*Mr. Serviceman*  
**SOUND IS HOT TODAY  
LAFAYETTE P.A. HOTTEST!**



**THEY'RE SELLING** sound systems hand-over-fist today. Theatres, dance halls, ball parks, cafeterias, churches, plants—all want Public Address. Get in—and add Lafayette, the BIG profit line to your line!

**LAFAYETTE GIVES YOU 3** complete lines to sell. Hit every price bracket with Lafayette's Economy, Standard and new DeLuxe models. Lafayette famed performance, Lafayette engineering experience, Lafayette amazing low prices make selling easy. Any way you take it, Lafayette has appeal!

**FIND OUT** how much lower Lafayette prices are. Find out how complete this line is. Send for **FREE** book today. Earn more money, full-time or spare, selling Lafayette streamlined P.A.! *The most complete line of sound equipment in the world.*

**LAFAYETTE RADIO CORPORATION**  
Dept. 3GP9  
100 Sixth Ave., New York, N. Y.

**LAFAYETTE**  
p. a. sales division  
NEW YORK ATLANTA CHICAGO

**RADIO of its BEST**



**W  
I  
T  
H**

**HQ-120-X**

**THE "HQ-120-X"** has become one of radio's most popular receivers. It includes everything that hams and fans have ever hoped for in a communications type receiver. Never before have so many new and outstanding features been built into a single unit. Many owners report that they are receiving and working stations that they never heard before. Such performance is due to the extremely high signal-to-noise ratio, ultra-sensitivity, and high selectivity. Among its many features are, calibrated band spread dial, improved noise limiter, variable selectivity crystal filter, improved "S" meter, antenna compensator and many others. For "radio at its best" use an "HQ-120-X". Write for 16 page booklet containing complete details.

Mail coupon today!

**HAMMARLUND MFG. CO., INC.**  
424-438 W. 33 St., N. Y. City RC-7  
 Please send 16-page booklet.

Name .....

Address .....

City ..... State .....



**HAMMARLUND**

Canadian Office: 41 West Ave. No., Hamilton, Ontario



# FOUR NEW 10¢ RADIO BOOKS!

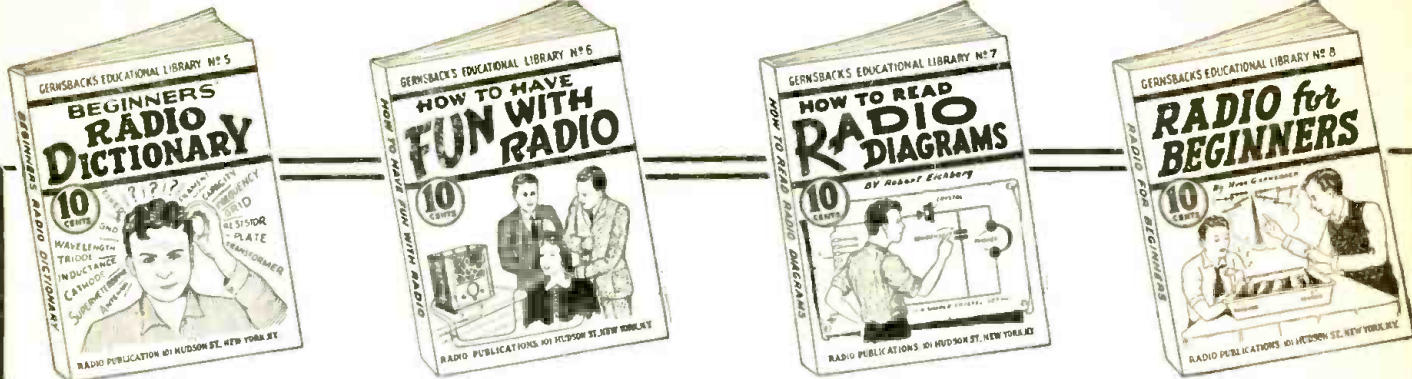

**RADIO FANS EVERYWHERE**—these little ten cent text books give you an excellent foundation for the study of radio. They are clearly written, profusely illustrated and contain over 15,000 words in each book. You'll be amazed at the wealth of information these volumes have. They are handy for review or reference books.

**NO. 5—BEGINNERS' RADIO DICTIONARY**  
Are you puzzled by radio language? Can you define frequency? Kilocycle? Tetrad? Screen Grid? Baffle? If you cannot define these very common radio words and dozens of other, more technical, terms used in all radio magazines and instruction books, you need this book in your library. It's as modern as tomorrow—right up to the minute. It tells you in simple language just what the words that puzzle you really mean. You cannot fully understand the articles you read unless you know what radio terms mean. This is the book that explains the meanings to you. Can you afford to be without it, even one day longer?

**NO. 6—HOW TO HAVE FUN WITH RADIO**  
Stunts for parties, practical jokes, scientific experiments and other amusements which can be done with your radio set are explained in this fascinating volume. It tells how to make a newspaper talk—how to produce silent music for dances—how to make visible music—how to make a "silent radio" unit, usable by the deafened—how to make toys which dance to radio music—sixteen clever and amusing stunts in all. Any of these can be done by the novice, and most of them require no more equipment than can be found in the average home. Endless hours of added entertainment will be yours if you follow the instructions given in this lavishly illustrated book.

**NO. 7—HOW TO READ RADIO DIAGRAMS**  
All of the symbols commonly used in radio diagrams are presented in this book, together with pictures of the apparatus they represent and explanations giving an easy method to memorize them. This book, by Robert Eichberg, the well-known radio writer and member of the editorial staff of RADIO-CRAFT magazine, also contains two dozen picture wiring diagrams and two dozen schematic diagrams of simple radio sets that you can build. Every diagram is completely explained in language which is easily understood by the radio beginner. More advanced radio men will be interested in learning the derivation of diagrams, and the many other interesting facts which this book contains.

**NO. 8—RADIO FOR BEGINNERS**  
Hugo Gernsback, the internationally famous radio pioneer, author and editor, whose famous magazines, RADIO AND TELEVISION and RADIO-CRAFT are read by millions, scores another triumph with this new book. Any beginner who reads it will get a thorough ground work in radio theory, clearly explained in simple language, and through the use of many illustrations. Analogies are used to make the mysteries of radio as clear as "2+2 is 4". It also contains diagrams and instructions for building simple radio sets, suitable for the novice. If you want to know how transmitters and receivers work, how radio waves traverse space, and other interesting facts about this modern means of communication, this is the book for you!

**Other Titles in This 10c Book Series!**

- No. 1—HOW TO BUILD 4 DOERLE SHORT-WAVE SETS
- No. 2—HOW TO MAKE THE MOST POPULAR ALL-WAVE 1- AND 2-TUBE RECEIVERS.
- No. 3—ALTERNATING CURRENT FOR BEGINNERS
- No. 4—ALL ABOUT AERIALS

Four other volumes in this ten-cent radio book series—each on a popular subject—are available. The titles are:

RADIO PUBLICATIONS, Dept. RC-739  
101 HUDSON STREET, NEW YORK, N. Y.  
Gentlemen: Please send immediately, POSTPAID, the book numbers circled below. I am enclosing \_\_\_\_\_ cents—each book being 10c.

Send FREE listing of 48 new 10c publications.

Name \_\_\_\_\_  
Address \_\_\_\_\_  
City \_\_\_\_\_ State \_\_\_\_\_  
Remit by check or money order—register letter if you send cash or unused U. S. postage stamps.

**MAIL COUPON TODAY!**

**BOOKS ARE ALL UNIFORM**  
Every book in the GERNSBACK EDUCATIONAL LIBRARY has 32 pages—with illustrations varying from 30 to 66 in number. Each title volume contains over 15,000 words. Positively radio's greatest book buy! If you do not think these books worth the price asked, return them in 24 hours and your money will be instantly refunded.

**RADIO PUBLICATIONS**  
101 Hudson Street New York, N. Y.

## THE LATEST RADIO EQUIPMENT

(Continued from page 34)

### NEW "TUBE MASTER" CHECKER (1760)

(John Meck Instruments)

**H**ERE is a new instrument which provides for performance tests of all tubes, including the new loctal, 35 V., 50 V., and tapped-filament rectifier tubes. The meter dial is translucent and illuminated from below. A neon test showing tube element shorts and leakage is included. Further, all types of ballast tubes may be checked. The instrument is designed as a portable job, in a leatherette carrying case. It may be used for counter work, too.

### 3 CHEERS! TERMINAL GUARDS FOR HIGH-VOLTAGE CONDENSERS (1761)

(Sprague Products Co.)

**F**OLLOWING the recent death or injuries to several amateurs from accidental contact with exposed high-voltage parts this far-sighted company has developed "life-guard" protective caps as a new and exclusive feature of its transmitting and other high-voltage condensers. These hard-rubber caps fit snugly over the condenser terminals affording complete insulation. Thus, there is no possibility of the operator making accidental contact with them.

It seems to us high time that manufac-

urers take cognizance of the fact that the increasingly high voltages being used today in radio, amateur and television receivers, are a menace to life. We hope eventually to see manufacturers of other parts used in high-voltage circuits follow the lead of the Sprague Products Company.

### NEW COAXIAL CABLE (1762)

(Belden Mfg. Company)

**A** NEW transmission cable, ideal for television work, using air as its principle dielectric, is announced by this company. It has been specially engineered for use as an antenna transmitting cable, in photoelectric and television circuits, and for other applications where a cable having unusually low-loss properties is desired.

The cable consists of a No. 12 solid tinned copper conductor over which is threaded a low-loss insulating bead. Over the beads is closely woven a tinned copper shield. The shield, in turn, is sheathed in rubber and the whole cable covered with a weather-proofed fabric braid which insures complete moisture and weather resistance.

### EXCITER TUNING UNIT (1763)

(Hammarlund Mfg. Co., Inc.)

**T**HIS new exciter tuning unit was designed for use in amateur all-band transmitter

Please Say That You Saw It in RADIO-CRAFT

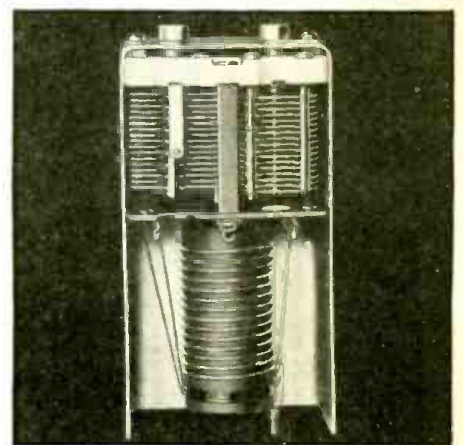

Exciter tuning unit for transmitters. (1763)

exciters. The units resemble I.F. transformers in appearance and consist of (a) 2 double-space midjet variable condensers, mounted on an Isolantite base, and (b) a coil. Each coil is wound with heavy wire on a threaded bakelite tube. A link coil mounted on the same tube permits the use of these units in either capacitive or link-coupled circuits. The units are available for the 80-, 40-, 20- and 10-meter amateur bands. Each unit measures 2 x 4 x 1 7/16 ins. deep. Designed to operate with type 6L6 tubes, these units should find wide application in modern up-to-date band-switching amateur transmitters.



**CONSTANT-VELOCITY RECORD  
"STANDARD" (1764)**

(Universal Microphone Co., Ltd.)

ACCORDING to the manufacturer this constant-velocity record (not illustrated) establishes a definite standard for the interpretation of the light patterns and volume levels, and puts an end to various arguments with regard to the relationship between light patterns and frequency response.

The new record is a standard 12-in. pressing, recorded at 78 r.p.m.—recording being in 3 parts. The first run consists of a glide frequency recording from 50 to 10,000 cycles, with breaks at 100, 200, 300, 400, 500, 1,000, 2,000, 3,000, 4,000, 5,000, 6,000, 7,000, 8,000, 9,000 and 10,000 cycles. During the breaks a voice announces the frequencies. With a background reference level of 0, the run

from 50 to 200 cycles is at plus 7 db., the run from 200 to 500, at plus 14, and the remainder up to 10,000 cycles at 21 plus db.

The second run is a 1,000 note in steps of 2 db. from plus 8 to plus 18, with silent breaks between steps in order to facilitate measurement of background level. The width of these steps can be measured lineally, and such measurement used for checking other recordings.

The final run is a 400-cycle note at a level of plus 18 db., zero reference being the background level of the record when using a standard point playback needle.

The new Universal Constant Velocity Record will be invaluable for calibrating pickups, checking turntable speeds, or for testing playback channels, in laboratories, colleges and schools, studios, stations. It can also be used in lieu of an audio oscillator where the expense of such an instrument makes its use prohibitive.

**ALL-PUSH-PULL DIRECT-COUPLED 10-WATT AMPLIFIER**

(Continued from page 18)

tials are the same as a single-ended job, in accordance with the voltages listed above.

Figure 1C shows a graphic voltage distribution of the amplifier. The ordinates are plotted at the right of the various elements which have been arranged in order of their applied potentials, in accordance with the above tabulation. Here, too, it will be graphically noted, that although approximately 150 volts are applied to the plate of the 6SJ7 (and to the control-grid of the 6L6), a negative bias is applied to this grid by making the cathode approximately 20 volts higher (at 170 volts from ground). All other element potentials are likewise distributed. Figure 1D shows the fundamental circuit arrangement to obtain the potential distribution plotted in Fig. 1C. Each resistor used, has been identified so as to make it easy to follow its position during the step-by-step development of the amplifier. If Fig. 1D is redrawn to conform with standard circuit design, Fig. 2A results.

It will be noted, that resistors E and F are used across the high "B+" and cathode of the 6L6 to obtain the plate potential for the 6SJ7's. This simple expedient avoids objectionable "trigger action," which was predominant in early direct-coupled amplifier designs. Inasmuch as the grid potential of the 6L6 is lower than the cathode potential, the original designers were tempted to obtain this voltage directly from the cathode, as illustrated in Fig. 2B. This circuit is greatly susceptible to "trigger action," because of the following sequence of events:

(1) When an instantaneous negative potential appears on the grid of the input tube, less plate current flows, and a smaller voltage drop takes place in the plate resistor G, so that the plate potential of the 6SJ7 tends to rise. Naturally, the grid potential of the 6L6 also rises, which in turn, decreases the effective bias of the output tube, and (2) increases its plate current, so that higher potential appears at the cathode, (3) which in turn raises the potential (through resistor G) on the output grid.

This cycle of events continues until plate current becomes excessive and the tube is thrown off its  $E_g-I_p$  curve, and maintains itself in a blocked position. This effect is popularly known as "trigger action." By employing resistors E and F (Fig. 2A), the plate potential of the input tube is independent of the plate current of the output tube.

**BASIC ALL-PUSH-PULL DIRECT-COUPLED CIRCUIT**

The extreme simplicity of making an amplifier push-pull throughout, suggests itself

as an ideal and simple manner to attain push-pull direct-coupled amplification without the use of any additional expensive components. In fact, *only two additional resistors are required*, as illustrated in Fig. 3, which is composed essentially of the basic direct-coupled circuit of Fig. 2A drawn with its "stereoisomer" (or mirror image) of the single-ended circuit.

The remarkable simplicity and symmetry of this circuit can best be observed by redrawing Fig. 3 as it appears in Fig. 4A. Here we see the essential components of a high-fidelity amplifier which is composed of 9 resistors (less the output transformer). This basic circuit is capable of developing 15 watts with less than 5%, and 10 watts with less than 2% of total harmonics. While the circuit looks extremely simple from a construction and wiring standpoint, and it really is, there are a number of complex hum-balancing, signal-balancing, and voltage-balancing bridge circuits contained therein, which become apparent, only when the circuit is redrawn as shown in Fig. 4B.

Here you will find we have a complex diagram composed of 4 interlinked bridge circuits. These circuits all contribute to circuit stability independent of tube variations, and elimination of hum without the necessity of using critical hum-balancing adjustments. If a large filter hum is introduced at the apex of the circuit (marked "Filter Hum"), it will be noted that all hum potentials will be evenly distributed between each half of the bridge circuit, so that for any hum potential introduced in one-half of the circuit, there will be an identical potential (equal in phase and amplitude) in the other half of the circuit. As long as this condition exists, cancellation will take place in the output transformer. This is further clarified in Fig. 4D.

If a hum potential is applied at the junction of the resistors E-D and passed through resistor G to the respective grids of the output tubes, both output plate circuits will behave identically. If an instantaneous positive value is assumed during the hum voltage cycle, both grids go positive at the same time. More plate current flows in each of the tubes, so that a voltage drop takes place at each plate terminal. Inasmuch as the primary winding of the output transformer is in opposite direction (which is a standard procedure for all push-pull output transformers), this hum voltage cancels itself in the primary, and no voltage appears in the secondary. This phenomenon, however, does not take place when a signal voltage is applied.

(Continued on following page)

Please Say That You Saw It in RADIO-CRAFT

**ARE YOU  
On Our List**



- Sales Bulletins
- Technical Bulletins
- Special Circulars
- Catalogs, etc.

**ON SPEAKERS**

If interested in radio, write us about these monthly mailings.

Those who KNOW

Demand Wright-DeCoster

**WRIGHT-DECOSTER, Inc.**

2251 University Ave., St. Paul, Minn.  
Export Dept.: M. Simons & Son Co., New York  
Cable Address: "Simontrice"

Canadian Representatives:  
Wm. F. Kelly Co., 1207 Bay St., Toronto, Ontario  
Taylor & Pearson, Ltd., Edmonton, Alberta

**RADIO made EASY**

with Ghirardi's Home  
Training Course  
**COMPLETE  
IN 7 BIG BOOKS**



Fit yourself at home, in spare time, for a good-paying radio job. You'll learn all that's really essential in Ghirardi's world-famous self-training course complete in this big 972-page volume—including Television, Sound, Cathode-Ray Tubes, as well as Radio and Electricity. All the basic theory is here, clearly explained, fully illustrated, easy to grasp!

**Quick Way to Learn!**

Ghirardi's simplified method is the quickest way to get your radio education. No "background" study—no math—no "headaches." Easy as A.B.C.!

**36 Volumes in 1—972 pp.—508 illus.**

1. Radio Broadcasting System. 2. Sound, Speech, Music. 3. Electron Theory; Elec. Current. 4. Elec. Units. 5. Ohm's Law; Resistance. 5. Elec. Circuits; Batteries. 6. Magnetism. 7. Electro-magnetism. 8. Electromagnetic Induction. 9. Inductance. 10. Capacitance; Condensers. 11. A.C. Circuits. 12. Filaments. 13. Measuring Instruments. 14. Radio Waves. 15. Broadcasting. 16. Receiving. 17. Vacuum Tube Principles. 18. Vacuum Tube Characteristics. 19. Vacuum Tube Construction. 20. Vacuum Tube Detector and Amplifier Action. 21. Radio Frequency Amplification. 22. "Substrates." 23. R.F. Amplifiers; Tuning Coils. 24. Audio Amplification. 25. Speakers. 26. Battery Operated Receivers. 27. Power-Supply Units. 28. Elec. Receivers. 29. Automobile and Aircraft Radio. 30. Phono Pickups; Sound Systems. 31. Short-Waves. 32. Photoelectric Cells; Cathode-Ray Tubes. 33. Television. 34. Antennas and Grounds. 35. Testing; Servicing. 36. Sound Pictures. 366 Review Questions.

**USE IT 5 DAYS OUR RISK!**

Get it!—Read it!—Use it! If not completely satisfied, return the book within 5 days and get your money back. You risk nothing—but you'll lose your great opportunity, unless you TRY IT!

**"MAIL COUPON TODAY!"**

Radio & Technical Publishing Co.  
45 Astor Place, New York, Dept. RC-79

Here is my \$4. Please send RADIO PHYSICS COURSE postpaid, with money-back guarantee.

NAME .....

ADDRESS .....

CITY ..... STATE .....

Send free descriptive literature.



## OPPORTUNITY AD-LETS

Advertisements in this section cost five cents a word for each insertion. Name, address and initials must be included at the above rate. Cash should accompany all classified advertisements unless placed by an accredited advertising agency. No advertisement for less than ten words accepted. Ten percent discount for six issues, twenty percent for twelve issues. Objectionable or misleading advertisements not accepted. Advertisements for August, 1939, issue must reach us not later than June 7th.

Radio-Craft • 99 Hudson St. • New York, N. Y.

### AGENTS WANTED

300% PROFIT SELLING GOLD LEAF LETTERS FOR store windows; Free samples. Metallic Company, 451 North Clark, Chicago.

### BUSINESS OPPORTUNITY

**DON'T THROW AWAY YOUR OLD RADIOS, CAMERAS, Tools, etc.** Get cash or trade for things you need. Big Double Offer—send 50c for year's subscription to "Sell & Sell." Receive Free stainless steel rule and depth gauge. Acme Publishing, Box 3332-D, Akron, Ohio.

### CAMERAS & SUPPLIES

**AMBERTINT 16MM. CAMERA FILM, \$1.85 FOR 100 feet.** Including machine processing. Daylight loading Weston Eight. Nonhazation. Two rolls \$3.50. Order now. Hollywood Studios, Southgate, Calif.

**GENERA FILM—ALL MOVIE CAMERAS, 100 FEET 8 mm., \$1.00; double, \$1.75; 16mm., \$1.35.** Sample for stamp. Processing Powders, Outfits. Fromaders. Davenport, Iowa.

**BULK FILM: 100 FT. 8MM. 5.90; DOUBLE, \$1.60; 16 mm., \$1.20.** Titles of pictures, Chemicals, outfits. Big catalogue for stamp. Hollywoodland Studios, South Gate, Calif.

### COINS AND STAMPS

**53 U.S.A. FARLEY'S, TIPEX, COMMEMORATIVES,** rev. postage, coronations, jubilees, air mails and lists 25c. Box 211, Malden, Mass.

### EDUCATIONAL COURSES

**USED CORRESPONDENCE COURSES AND TECHNICAL** books, bought, sold, rented, exchanged. Catalog free. Vernon's Exchange, Henagar, Alabama.

### FOR INVENTORS

**CASH FOR UNPATENTED IDEAS, STAMP APPRECIATED.** Mr. Ball, 9441-J Pleasant, Chicago.

### FORMULAS

**FORMULAS FOR MAKING INSECTICIDES, ANTISEPTICS,** Bleaching Solutions, Cements for all purposes, Stain Removing Preparations, Cosmetics, Depilatories, Dyes, Fertilizers, Fire Extinguishing Preparations, Inks, Lacquers, Paints, Plating Solutions, Soaps, Varnishes, Wines and Liquors, and Many Everyday Preparations. Send 10c for each formula. Complete satisfaction or money immediately refunded. Albert Stuart, 1015 Wilson Ave., Teaneck, N. J.

### MISCELLANEOUS

**MEXICAN DIVORCES; NO PUBLICITY. AMERICAN** attorney. Box 1736, El Paso, Texas.

**BOYS, GIRLS, AGENTS; MEXICAN JUMPING BEANS,** 5 for 10c. 15—25c. J. J. Frank, 525-L Palm, Rockford, Ill.

**10 ARROWS FROM 10 DIFFERENT STATES—\$1.00.** 100 good arrows prepaid—\$3.00. 100 fine arrows prepaid—\$5.00. List free. Caddo Trading Post, Glenwood, Ark.

### MONUMENTS & TOMBSTONES

**GENUINE MARBLE, GRANITE, FREIGHT PAID.** Catalog free. \$11 up. United States Marble & Granite Co., A-27, Oneco, Fla.

### OFFICE SUPPLIES

**SEND COPY AND \$1.00 FOR 125 8 1/2 x 11 BOND LET-** terheads and 125 envelopes, both beautifully printed. Benneville, 907 West Roosevelt, Philadelphia.

### RADIO

**WE BUY AND SELL USED RADIO TESTING EQUIP-** ment. Time payments if desired. Harold Davis, Inc., Jackson, Miss.

**SERVICEMEN: RADIO CARTOONS ENLIVEN AD-** vertising, boost business. Cut catalogue 10c. Radiotabs, Winnipeg, Canada.

**ALGEBRA PROBLEMS SIMPLIFIED \$1.30; LOW** Voltage Transformer Construction \$0.60; Data on 500 to 20,000 Volt Step-up Transformer Construction \$1.35. H. Ackerson, Box 322-R, Ramsey, N. J.

**BRAND NEW, GUARANTEED, RADIO TUBES 25c** each. Box 37, Station P, Brooklyn, N. Y.

### REFRIGERATION

**REFRIGIDAREA REFRIGERATION SERVICE MAN-** ual. Trouble prevention, diagnosis, repairs. \$1.50. Barnes', 1627-N. Elken, Tulsa, Okla.

### SHOP EQUIPMENT

**SURPLUS STOCK OF BENCH METAL TURNING** lathes, electric motors, hand grinders, shop equipment. Box 416, Cedar Rapids, Iowa.

### SONG POEM WRITERS

**SONGWRITERS! MELODY FOR WORDS \$1.00.** Lattig, 215 Mason Theatre, Los Angeles, California.

## BUILD YOUR OWN RADIO

**ANYONE CAN DO IT!**  
It's easy! Just follow our simple instructions and plans. Results guaranteed! Write for full particulars.  
**N. J. ENGINEERING CO.**  
2337 Grand River, Detroit, Mich.



plied, for under this latter condition, one grid goes positive, while the other goes negative.

If you will refer back to Fig. 4B and select any resistor in the "B+" or filter hum voltage network which may induce undesired hum into any grid circuit of the amplifier, it will be found that the same hum voltage is applied to its push-pull mate, and ultimately cancels in the output transformer.

It is for this reason, that the hum level of the amplifier can be brought down to -70 db. below maximum output, without the use of hum-balancing adjustments.

### AUTOMATIC COMPENSATION FOR VARIATIONS IN TUBES

A large number (of the same type) of tubes were interchanged in the amplifier without noting any appreciable difference in performance. The apparent reason for this is evident by the additional study of Fig. 4B. Reasonable variations in plate or screen-grid currents of the 6L6 output tube cancel at their cathodes. Variations in the input 6SJ7 tube are likewise cancelled at the junction of their cathodes. It is obvious, of course, that any tube which will not operate satisfactorily in a standard amplifier should not be used in this unit.

Another existing hum-cancellation bridge is noted in Fig. 4C which is the output stage and its associated filter condensers re-drawn in a bridge circuit form. Here, it will be noted that the capacitive reactance of the 20 mf. condenser (which is approximately 96 ohms) and the 30 mf. condenser (approx. 64 ohms) is approximately proportional to the hum distribution in this portion of the filter network. The hum distribution may be considered proportional to the D.C. voltage distribution. This type of an arrangement insures against excessive hum at points X and Y, regardless of the variable effects of the mu of the 6L6 screen-grids.

### CALCULATION OF RESISTOR VALUES

The design procedure necessary to calculate the values of the important 6 resistors required, makes use of an elementary application of Ohm's Law. There are only two design precautions which must be kept in mind, and these are:

- (1) The voltage drop in the plate resistors G, should be made equal to the voltage drop in the plate circuit of the input tubes, i.e., 150 volts; which means that the voltage applied to the high-potential side of the G resistor should be 2 x 150=300 volts. This voltage should appear at the junction of resistors E and F.
- (2) The bleeder current through resistor F should be exactly equal to the plate and screen-grid currents required by both input tubes, i.e., (1.5+0.5) X 2=4 ma.

With these points in mind, it is extremely simple to calculate the values of all the resistors based on a voltage drop across, and current through, each one. The following tabulation indicates the formulas used:

### RESISTOR

$$(B) \frac{3}{0.004} = 750 \text{ ohms}$$

$$(F) \frac{125}{2[2(1.5+0.5)] \text{ ma.}} = 15,600 \text{ ohms}$$

$$(E) \frac{130}{2(1.5+0.5) \text{ ma.}} = 32,500 \text{ ohms}$$

$$(D) \frac{95}{2(65+6.5)+1+4 \text{ ma.}} = 640 \text{ ohms}$$

$$(C) \frac{75}{148-1} = 505 \text{ ohms}$$

$$(G) \frac{150}{0.0015} = 100,000 \text{ ohms}$$

(A) May be a conventional 1/2-meg. grid resistor

The watts rating of each of these resistors should be between 2 and 3 times its actual watts dissipation, so as to provide a minimum safety factor of 50%.

### TWIN-CHANNEL OPERATION!

Figure 5 is a completed basic circuit of the All-Push-Pull Direct-Coupled Amplifier. The output transformer, volume control and tone control have been intentionally omitted, as there is a large number of possible variations in these 3 elements, depending upon the final application of the amplifier. If a separate output transformer is used for each side of the circuit, and separate input signals are applied, twin-channel amplification is effected, making this unit admirably adapted for reproduction of sound in "auditory perspective."

If each one of 2 microphones is independently fed into each one of the 2 input circuits, as Fig. 6A, and 2 speakers are correctly placed in an auditorium, so as to bear the same relative positions as the microphones, amplification in auditory perspective will take place. For this application, two independent half-meg. potentiometers replace the (A) resistors. This same input and output set-up will also enable 2-way communication between any two remote points, without the use of talk-listen switches (see Fig. 6B).

The amplifier can also be used for recording and playback, or any other, similar duplex arrangement, without the necessity of switches. In the usual recording amplifier (with single input and single output) it is necessary to switch a number of circuits before playback can take place. In the twin-channel amplifier (see Fig. 6C) a microphone feeding into the 1st channel can operate the cutter (connected to the output of the 1st channel), and a crystal pickup (for playback) can be connected to the input of the 2nd channel. A speaker connected to the output of the second channel completes the playback system.

This same arrangement can also be used for introduction of "artificial reverberation," or echo, simply by providing a time delay in one of the amplifier circuits. This is illustrated in Fig. 6D. With this arrangement, part of the original amplified signal from channel No. 1 is sent through an echo chamber or other acoustic time delay unit, such as a long pipe. This sound is picked up and sent through channel No. 2, and is ultimately reproduced along with some part of the original signal, so that the effects of reverberation or echo are obtained.

For conventional push-pull operation, it is necessary to use a good push-pull output transformer, together with a twin half-meg. potentiometer, as illustrated in Fig. 7A. In order to obtain push-pull operation of the input tubes, it is necessary to feed a push-pull signal into the input of the amplifier. This is obtained by removing one of the phono pickup or microphone leads from ground, and feeding in through a 2-wire



shielded cable. Microphones and pickups are easily attainable for this type of cable connection.

**INPUT AND OUTPUT TRANSFORMERS**

If it is impossible to isolate one of the leads of the input signal from ground, or if a low-impedance (200- or 500-ohm) input device be connected to the amplifier, an input transformer must be used as per Fig. 7B. In order to attain true high-fidelity reproduction, this unit should employ an "electric metal" core, and should match the input device to the input of the amplifier (100,000 ohms, grid-to-grid). Hum-balancing construction should be utilized to avoid excessive hum pick-up.

Needless to say, it is impossible to design or construct transformers which will have a response comparable to that of the amplifier. In fact, a wide-range output transformer capable of passing 10 to 20,000 cycles with less than 1 db. variation, would cost approximately \$20. In order to enable the use of a low-priced output transformer with this unusual amplifier, a special push-pull inverse feedback and compensating network circuit was employed, which is illustrated in Fig. 8. This circuit enables a \$1.50 transformer to equal the performance of a \$20 unit!

**TONE CONTROL CIRCUIT**

It appears to be sacrilegious to add a frequency discriminating arrangement to this ideal amplifier. Nevertheless, existing deficiencies in speakers, transmission lines, microphones and pickups necessitate such an adaptation.

The frequency discriminating network should be connected in the input circuit across both grids of the 6SJ7 as per Fig. 9, or in series, or shunt, with the input device, depending upon the type of equalization desired. A standard tone control (of the high-frequency cut-off) is indicated in the List of Parts, although this type of circuit need not be followed, as any other form of equalization may be effectively employed.

The writer hopes that this discussion will bring to the front the hidden possibilities of the direct-coupled amplifier circuit; and he will gladly answer all questions relative to the adaptation of this or any other direct-coupled amplifier for any commercial or industrial application. All inquiries should be addressed c/o *Radio-Craft*.

**LIST OF PARTS**

**Basic Amplifier**

- One Amplifier Co. of America power transformer, type PTL6 10 D.C., P.T.;
- One Amplifier Co. of America filter choke, type 60CH 125, Ch.;
- Two Mallory condensers, 10 mf., 450 V.;
- One Mallory condenser, 20 mf., 450 V.;
- One Mallory condenser, 30 mf., 450 V.;
- Two Erie Resistor Company resistors, 2 megs., ½-W.;
- Two Erie Resistor Company resistors, ¼-meg., ½-W.;
- Two Erie Resistor Company resistors, ½-meg., ¼-W.;
- Two Erie Resistor Company resistors, 0.1-meg., ½-W.;
- One Erie Resistor Company resistor, 15,600 ohms, 2 W.;
- One Erie Resistor Company resistor. 750 ohms, ½-W.;
- One Hardwick, Hindle, Inc., resistor, 640 ohms, 30 W.;
- One Hardwick, Hindle, Inc., resistor, 505 ohms, 20 W.;
- One Erie Resistor Company resistor, 32,500 ohms, 1 W.;

One Amplifier Co. of America chassis and foundation kit;

**Optional Accessories**

- Two RCA or Sylvania type 6SJ7 tubes (or 6J7);
- Two RCA or Sylvania type 6L6 tubes (or 6L6G);
- One RCA or Sylvania type 5V4G tube;
- One Amplifier Co. of America push-pull output transformer, OTL6 10 D.C.; or
- Two Amplifier Co. of America single output transformers, OTL6, 5 D.C.;
- One Centralab dual shielded volume control, ½-meg.; or,
- Two Centralab volume controls ½-meg.;
- One Amplifier Co. of America hum-bucking and shielded input push-pull transformer, 200 and 500 ohms; or,
- One Amplifier Co. of America high-impedance hum-bucking and shielded input transformer;
- One Centralab tone control, ½-meg.;
- One Micamold condenser, .003-mf.;

**Resistors and Condensers for Use with Output Transformer**

- Two Micamold condensers, 1 meg., ½-W., 600 V.;
- Two Micamold condensers, 0.003-mf., 600 V.;
- Two Micamold condensers, 0.006-mf., 600 V.;
- Two Erie Resistor Co. resistors, 5,000 ohms, 1 W.

**Dear Editor . . .**

*(Continued from page 16)*

Nevertheless, its response is flat from 1 cycle per minute to 20,000 cycles per second.

Unfortunately, there are no signal generators to produce such a low frequency, and there are no output meters available capable of measuring this low frequency response. We therefore had to adopt a new method for measuring these unusually low frequencies, by introducing a small varying voltage into both grids. This is done by connecting a dry-cell into the input circuit and slowly varying the volume control from 0 to full setting.

The output voltage is measured by a cathode-ray oscilloscope in the same manner that D.C. would be measured.

The amazing simplicity of the circuit, its unusually low hum level, its extraordinary performance, and its extremely low price (a complete kit can be purchased for less than \$10) make me feel certain that this amplifier fills a long-felt want.

It will be a pleasure for me to answer all questions that any of your readers may have regarding the design, construction or application of this new (patent applied) All-Push-Pull Direct-Coupled Amplifier.

A. C. SHANEY,  
Chief Engineer.

P.S. The high-frequency response seems to be unlimited, as there are unusually low distributed capacities present in the tubes employed. Although we made no measurements above 20M cycles, I believe that its response can be extended out to radio frequencies, which makes this unit also admirable for television application at the video frequencies.

A. C. S.

**TELEVISION AT THE FAIR**

When you go to the New York World's Fair, 1939, look for television demonstrations at the following exhibits: RCA, General Electric, Westinghouse, Ford (G.E. set), Crosley (Du Mont set).

Please Say That You Saw It in RADIO-CRAFT

**New SMALL SIZE GOING OVER IN A BIG WAY**



retails at **15c**  
May also be had in 2-oz. 50c bottles

Cleans, lubricates, preserves original hi-fidelity quality. Indispensable wherever records are enjoyed. Don't be without this famous Liquid Renewer!

**SUPERIOR PLAYBACK NEEDLES**  
10 PLAYS to a needle: remarkable hi-fidelity and minimum surface noise; once tried, always used!

**RECOTON CORPORATION**  
178 Prince Street  
New York City

**PORTABLE BATTERY RADIO**

List \$29.95 **\$18.00**  
VERY SPECIAL

COMPLETE CHASSIS \$12.00

Dealers Get Busy! Marvelous Rental and Sales Money-Maker.

**SOLTER RADIO COMPANY,**  
103 No. 7th St., Minneapolis, Minn.

**RADIO ENGINEERING and TELEVISION**



Train at home in your spare time for a better radio job and more money in this expanding field. CAREER men succeed—write for FREE illustrated BOOKLET for complete details and how we can help YOU improve your position.

**CAPITOL RADIO ENGINEERING INSTITUTE**  
Dept. RC-7  
3224 16th St., N.W., Washington, D.C.

**ELECTRICITY FROM YOUR OWN ELECTRIC PLANT WHEN POWER LINES FAIL**

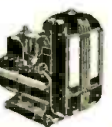

ONAN A.C. ELECTRIC PLANTS supply current for Radios, Transmitters and Receivers, P. A. Systems, Movie Projectors, Sound Truck Apparatus, Tools, Lights. All Appliances Used as Standby Equipment in Schools, Hospitals, Theatres and Public Buildings in case of Power Line Failure due to Storms, Floods, etc. Available in 110 or 220 Volt A.C.—12, 32 and 110 Volt D.C.—Also Dual Voltage AC-DC Types. Manual, Full Automatic & Self-Starting. \$89 and up. Shipped, Ready to Run.

**D. W. ONAN & SONS**  
684 Rosalton Avenue Minneapolis, Minn.

**PATENTS—TRADE MARKS**

Booklet concerning Inventions & Patents Form "Evidence of Conception" with instructions for use and "Schedule of Government and Attorneys Fees"—Free

**LANCASTER, ALLWINE & ROMMEL**  
Registered Patent Attorneys  
436 Bowen Bldg. Washington, D. C.

**TELEVISION CYCLOPEDIA**

Defines and explains all television terms now used and gives actual applications. Covers in detail every phase of modern cathode-ray television. Every radio man, amateur, and student of television needs this new book. It will simplify TELEVISION for you. Compiled by M. N. Beltman. Only \$1.00, postpaid.

**SUPREME PUBLICATIONS**  
3727 West 13th St. Chicago, Illinois



# FREE - REAL ELECTROPLATING OUTFIT



Now  
You Can **ELECTROPLATE**  
Easily with a **BRUSH**

SOMETHING new for radio men—something which gives you the opportunity to make additional profits—or to improve your type of service. Here's an **ELECTROPLATING KIT** amazingly simple to operate—you just Electroplate with a Brush!

## NOT A TOY!

You can electroplate for profit, hundreds of things in the household—ashtrays, fixtures, water faucets, worn brackets, door knobs, musical instruments, jewelry and silverware and other articles. It's an indispensable piece of equipment to you for plating articles in hotels, apartments, office buildings, medical and dental offices, factories, schools, laboratories, etc. Exactly the same outfit (but larger) is used professionally by electricians, radio service men, automobile repair shops, etc. Requires one single dry cell 1½-volt battery to operate.

And for radio work, you can electroplate tarnished receiver parts, escutcheons, contacts, worn radio parts and accessories, and display chassis. Put this **REAL ELECTROPLATING KIT** to use immediately—make it the most useful article in your shop or laboratory. And, you can get it absolutely **FREE** (except for slight mailing cost).

Send your subscription today to **RADIO-CRAFT** for One Year (12 issues) and receive absolutely **FREE** this **REAL ELECTROPLATING KIT**. New subscribers are accepted or you may extend your present subscription another twelve months under this offer. Mail your remittance of \$2.50 (plus 10c for shipping charge on kit) to the publishers of **RADIO-CRAFT** (Canada and foreign \$2.85). You will promptly receive your **FREE, REAL ELECTROPLATING OUTFIT** by return mail. Use the coupon below to order your subscription.

## RADIO-CRAFT

99 Hudson Street New York, N. Y.

RADIO-CRAFT RC-739

99 Hudson Street, New York, N. Y.

Gentlemen: Enclosed you will find my remittance of \$2.50 for which enter my subscription to **RADIO-CRAFT** for One Year (12 Issues). Send me promptly my **FREE, REAL ELECTROPLATING OUTFIT** (Canada and foreign \$2.85). In U. S. add only 10c additional to cover shipping charges on kit.

New Subscriber  Extend Present Subscription

Name .....

Address .....

City ..... State .....

(Send remittance by check, money order or unused U. S. Postage stamps. Register letter if you send cash or stamps.)

## 1939 COMMERCIAL TELECEIVER

ON pg. 26 of this issue is a complete schematic diagram of the RCA Victor models TRK 9 (9-in.) and TRK 12 (12-in.) telereceivers. The diagram covers only the television sight portion and part of the television sound portion—and we hope next month to publish that of the remaining sound portion, and the associated broadcast receiver and power supply unit. More specifically, these receivers are designed for operation on the present television broadcast bands between 44 and 90 megacycles to reproduce both picture (image) and sound transmissions, and to receive in addition radio broadcasts on the standard broadcast bands.

The information following has been excerpted from the Owner's Manual supplied with each television receiver. This material is of interest to the radio Serviceman inasmuch as it outlines the RCA Victor television service policy as well as the many precautions advised upon the owner. The following information pertains specifically to the RCA model TRK 9 television receiver but is applicable in its general aspects to the TRK 12.

### WARNING

The Manufacturer's guarantee is valid only in the event that the Guarantee Registration card is filled-in and mailed to the RCA Manufacturing Co. Also the unpacking and installation must be carried out by a competent television technician, and no unauthorized person, at any time, may tamper with the assembly, wiring, adjustments or circuits.

This Television Receiver is a precision instrument and its installation with an effective antenna for best image reception is a matter of involved detailed knowledge and experience. When your authorized television technician has made the installation and demonstrated the receiver to your satisfaction in your home, it is a perfectly safe and reliable instrument for your entertainment, easy to operate and should only require very occasional servicing or readjustment.

However, if you have any trouble or difficulty with the operation immediately turn off the power, call in your dealer and do not attempt to make any adjustments which you were not definitely advised to do at the time of installation. Also if you wish the instrument to be moved call your dealer as readjustments may be necessary.

This Television Receiver contains apparatus producing high voltages. No one but a trained television technician should make repairs or adjustments to the television apparatus.

A good ground connection from the terminal "G" on the antenna terminal board to a cold-water pipe or equivalent "good ground" is absolutely necessary to avoid possible danger from electric shock.

The receiver is equipped with 2 safety lock-in switch devices and when the back is removed power is cut off from all the high-voltage television apparatus. The switches are toward the bottom of the cabinet on the inside of both side panels. No danger is possible from the high-voltage television apparatus unless both these switches are *simultaneously* pushed in. Under no circumstances should anyone tamper with these switches.

### TECHNICAL DATA AND CIRCUITS

The RCA Model TRK 9 Television and All-Wave Sound Receiver is designed for operation on the present Television Broadcast Bands between 44 and 90 megacycles to reproduce both image and sound transmissions, and to receive Radio Broadcasts

on the 3 standard major radio bands between 550 and 22,000 kilocycles.

Once the TRK 9 is installed and giving good reception, the controls on the front panel are all that are necessary for satisfactory images and sound. If the instrument is moved to another location in the home, the screwdriver-operated controls in the side, and also the Kinescope yoke, may have to be reset by a competent technician. *The ground connection to the antenna terminal board must always be connected, before plugging in the power cord.*

The High-Voltage power for the Kinescope is on, only when the back is "locked-in" and properly attached, the Power-Volume Control turned on, and the Fidelity Selector Knob turned to "Television."



RCA Victor Television Receiver Model TRK 12. Has 12-inch Kinescope which reproduces an image 7½ x 9¾ inches on a mirror on the underside of the raised lid for indirect viewing. Reproduces images in unusually fine detail. Utilizes 36 tubes in addition to Kinescope. Electric tuning for sound reception is provided for 9 stations. Cabinet is of fine matched woods, and measures 40½ x 34½ x 19½ ins. deep.

### ELECTRICAL SPECIFICATIONS

**Television Chassis.**—High-frequency superheterodyne with separate Video and Audio I.F. channels, separate detectors and automatic volume controls, station selector with fine tuning, double-purpose antenna coupling, video circuit with automatic background, interlaced scanning, magnetic deflection circuit and electrostatic focusing.

**Radio Set Chassis.**—Superheterodyne with automatic volume control, fidelity control, Magic Eye indicator, electric pushbutton motor tuning and class A-B push-pull pentode output system with inverse feedback (see diagram, next month).

### TELEVISION FIXED CONTROLS

Information for Television Technician

1. **Horizontal Centering.**—This is a screwdriver adjustment at the left of the row. It serves to center the image horizontally on the Kinescope screen and is made at the time of installation of the receiver. It may require resetting, due primarily to the earth's magnetic field, if the receiver location is changed, the cabinet turned around, or the Kinescope replaced.

2. **Width.**—The next screwdriver control determines the width of the image, and is adjusted when the receiver is installed. Further adjustment may occasionally be necessary in order to compensate for the gradual reduction in horizontal deflection with tube life.

3. **Vertical Linearity.**—The 3rd control is operated in conjunction with the Height Control, No. 4, to give the correct vertical proportions to the image. It may require readjustment due to changing of the Height

Please Say That You Saw It in **RADIO-CRAFT**





# PERMEABILITY TUNING IS HERE

SEND FOR  
*Free Book!*

**Q CONTROL**  
TRADE-MARK

ALADDIN RADIOD INDUSTRIES, INC.  
486 WEST SUPERIOR STREET  
DEPT. C  
CHICAGO, ILLINOIS

Licensed under one or more of the following Johnson Laboratories, Inc. patents:  
1,940,228  
1,978,600  
1,982,689  
1,982,690  
2,019,626  
2,051,012  
2,113,603  
Other patents issued and pending.

Control and due to the gradual aging of the tubes. If the image fills the frame but is crowded near the top, turn Vertical Linearity control clockwise and Height Control counterclockwise. If crowded towards the bottom, turn both these controls in the reverse directions.

4. *Height.*—The 4th control determines the height of the image and is adjusted in conjunction with Vertical Linearity when the receiver is installed. Further adjustment will occasionally be necessary in order to compensate for the gradual reduction in vertical deflection with tube life.

5. *Vertical Centering.*—The screwdriver adjustment at the right of the row serves to center the image vertically on the Kinescope screen and is made at the time of installation. It will require resetting whenever the receiver location is changed, the cabinet turned around, or the Kinescope replaced.

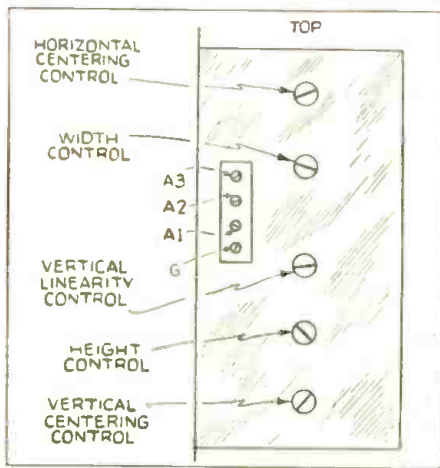

The "fixed" controls used by television Servicemen for adjusting the image.

## SERVICING TELEVISION RECEIVER FAULTS

(Continued from page 25)

have only to assign values to R and R1 such that the ratio of  $R + R + R1 = 1/M$  or more simply  $1 + R1/R = M$  where M is the amplification provided by V2, and  $R2 = R + R1$ . For example, assume V2 provides a gain of some 10 times with  $R2 = 100,000$  ohms, then also,  $R + R1 = 100,000$  ohms (where  $R = 10,000$  ohms, and  $R1 = 90,000$  ohms).

### CHECKING BALANCE

A simple manner in which to determine when the balance is correct is to remove the tube V2, when the image should be substantially one-half the width or height previously obtaining. Some care should be exercised if this latter scheme is adopted in order to ensure that it actually is the tube V2 that is removed. Obviously if V1 is removed the

only one form of balanced output. For some arrangements the scan will not collapse upon removal of either tube. However, as the circuit depicts the arrangement generally encountered it is well to bear in mind this point.

There remains only one form of raster distortion likely to occur. It is proposed to deal with this now so that we may concern ourselves in the next article with actual vision receiver faults. This distortion, which, unfortunately, frequently occurs, is due to the presence of A.C. ripple (hum) in the time base high-voltage supply.

The remedy, of course, is to increase the measure of smoothing provided. Where the time base high-voltage is adequate it often is convenient to effect this end by including a fixed resistance and condenser in the smoothing arrangements. Failing this, it will be necessary to include an additional choke and condenser. Either of these arrangements is satisfactory and whichever is adopted will depend upon the adequacy or otherwise of the high-voltage.

### A.C. RIPPLE

The effect of A.C. ripple in the time bases is readily apparent. It is illustrated by Figs. 10 and 11.

It is seen that these faults, as were those for trapezium distortion, are depicted by drawings. This is more satisfactory in these cases for the effects can be exaggerated and thus rendered plainer.

Considering first Fig. 10. This fault is caused by the presence of A.C. ripple in the line (horizontal) deflecting circuit. It is seen that the effect is to displace the edges of the image giving them a wavy appearance. This distortion is not restricted to the edges only and will result also in an actual corollary displacement of the reproduced image.

In Fig. 11 the result of A.C. ripple in the frame (vertical) deflecting circuit is depicted. In this case it is seen that there is apparent an uneven spacing of the line formation.  
(Continued on following page)

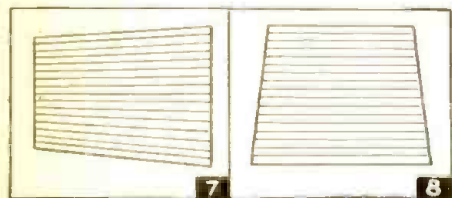

Figs. 7 and 8. Showing the effect of trapezium distortion caused by unbalanced sweep voltages. The line formation is exaggerated.

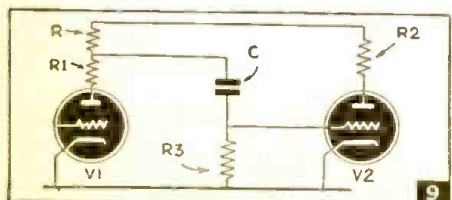

Fig. 9. Circuit of a conventional balanced-out amplifier. A portion of the output of tube V1 is fed to tube V2. (Plate voltage is applied to the lead connecting R and R2.)

scan will collapse and there is a strong possibility of a line being burned on the screen. Of course, the circuit shown by Fig. 7 is

## BRUSH • BJ HEADPHONES

Communications type—lightweight, durable aluminum case—phones encased in molded rubber jackets—good earseal.



Write for your Brush catalog today

**THE BRUSH DEVELOPMENT CO.**  
3311 Perkins Ave. Cleveland, Ohio



### JOIN OUR RECORD CLUB

Send for your copy of this big 500 page Record Catalog & Encyclopedia. Contains lists of thousands of famous records and musical data on pronunciations and dates of composers; 25¢ plus 10¢ for mailing. (stamps or coin) It also enrolls you in our Record Club. We carry a large selection of records from 10¢ up. Write today.

**MODELL'S** 58 Cortlandt St. 301 New York City

## SAVE MONEY

ON RADIO SETS AND PARTS

SEND FOR OUR FREE GIANT NEW CATALOG ILLUSTRATING AND DESCRIBING OVER 1,000 MONEY SAVING ITEMS.

**UNITED RADIO COMPANY**

BOX 1000 NW-NEWARK, N. J.



### EVERYTHING IN RADIO!

A COMPLETE SOURCE FOR YOUR RADIO NEEDS  
Our immense stock of radio sets, parts and supplies enables you to purchase your entire needs on one order. You will find all your Nationally Known Favorites in this big book which is FREE for the asking. Practically every order is shipped the same day it is received. WRITE FOR BIG NEW CATALOG

**BURSTEIN-APPLEBEE CO.**  
1012-14 McGee St. Kansas City, Mo.

## NAALD TELEVISION COMPONENTS

When you check the new television sets which have been so completely engineered to assure dependable operation and service, you will find a large number of NAALD components—there is assurance in NAALD Quality.

Write us for bulletin of television parts so that you may be the earliest to stock them in your territory.

**ALDEN PRODUCTS COMPANY** Dept. RCJ  
Brockton, Mass.

**FREE AMPLITONE**  
New 1939 Sound Catalog  
Illustrating our complete line of modern sound equipment.  
Write for your FREE COPY NOW!  
**AMPLITONE PRODUCTS CO.**  
135 Liberty St. New York City, N. Y.

Please Say That You Saw It in RADIO-CRAFT



Attractive  
**MODERN DESK LAMP**  
 Absolutely **FREE**  
 READ THE DETAILS . . .

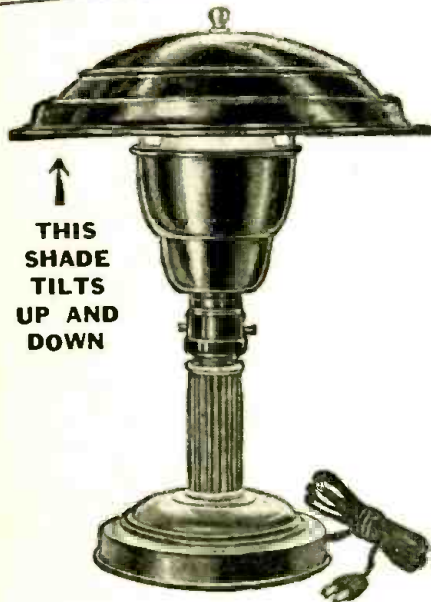

**JUST THINK OF IT**—you can get absolutely **FREE**, the beautiful desk lamp which is shown above. This attractive desk lamp is suitable for home, desk, den, office, laboratory, studio or workshop. It is sent to you by the publishers with their compliments for a one-year subscription to **RADIO-CRAFT**. Look at the many fine features which this handsome desk lamp has. Read the list below.

#### HERE ARE THE LAMP FEATURES!

- ① Constructed of metal with attractive bronze finish.
- ② Scientifically constructed to give glareless, diffused light.
- ③ Helmet-type shade can be tilted to any convenient angle.
- ④ Stands 13" high and has 10" metal shade.
- ⑤ 5-foot rubber insulated cord and plug.
- ⑥ Constructed to last for many years.

#### Clip Coupon Today—and Mail!

Send your subscription today to **RADIO-CRAFT** for One Year (12 issues) and receive absolutely **FREE** one of these truly remarkable desk lamps. New subscribers are accepted or you may extend your present subscription another twelve months under this offer. Mail your remittance of \$2.50 (Plus 25c for shipping charges on lamp) to the publishers of **RADIO-CRAFT**. (Canada and foreign \$3.25.) In U. S. add 25c additional to cover shipping charges on lamp.

### RADIO-CRAFT

99 Hudson Street NEW YORK, N. Y.

#### RADIO-CRAFT

99 HUDSON STREET, NEW YORK, N. Y.

Gentlemen: Enclosed you will find my remittance of \$2.50 for which enter my subscription to **RADIO-CRAFT** for One Year (12 issues). Send me promptly my **FREE DESK LAMP**. (Canada and foreign \$3.25.) In U. S. add 25c additional to cover shipping charges on lamp.

- ( ) NEW SUBSCRIBER  
 ( ) EXTEND PRESENT SUBSCRIPTION

Name .....

Address .....

City ..... State .....

(Send remittance by check, money order or unused U. S. Postage stamps. Register letter if you send cash or stamps.)

RC-739

tion. It is fortunate that the image repetition frequency adopted for the present transmission standards is an integral multiple of the frequency of the mains supply, for otherwise this uneven line formation would pass vertically across the image giving rise to very distressing effects. As it is, with the time base locked by the transmitted sync. pulses, this uneven line spacing is rendered stationary and close examination permits its presence to be readily determined.

The remedy in both cases has been indicated. It is to increase the measure of smoothing provided for the high-voltage supply to either one or to both the time bases.

One point in connection with Figs. 10 and 11 is worthy of mention. The figures depict the presence of a 50-cycle ripple. (Nearly the same for 60 cycles, as used in most sections of the U. S.—*Editor*). In some cases this ripple will have a frequency of 100 cycles (120 cycles, in U.S.A.—*Ed.*),

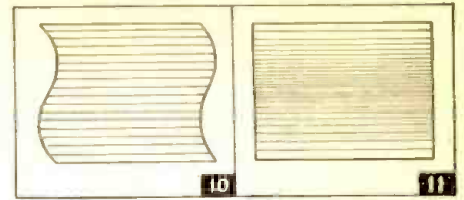

Fig. 10. A.C. ripple in horizontal (line) time base.  
 Fig. 11. A.C. ripple in vertical (frame) time base, resulting in uneven line spacing.

depending upon the arrangements adopted in the high-voltage supply unit. In this case the effect is substantially the same but will be duplicated in the image. Identical procedure is adopted in order to remove the fault.

In the next article, faults attributable to incorrect design or manipulation of the vision unit will be dealt with.

(To be continued)

## RADIO TRADE DIGEST

### TELEVISION BOOM STARTS

(Continued from page 35)

of time to pay—which they could not always get. Large-image sets were definitely luxury item; comments included "Heck, I could buy a car for less!" (How about it, Crosley?)

Dealer opinion indicated that mfrs. should dunk prices of more costly models, taking a beating at first if necessary. They felt that first buyers of big sets were paying too great part of development & tooling costs—that these should be spread over longer period.

Paucity of programs was (surprisingly) not a deterrent to sales, public figuring that pros would soon be increased. Also little worry on score of obsolescence. Major worry was that prices would drop in few months, & that first buyers would be stuck suckers.

All in all, it looks as though telly would prove to be the hypodermic needed to give radio biz much-needed stimulation. What public wants is large pix & good programs. They will pay for them—but not in great numbers unless set prices take tumble. Small-image sets will sell at moderate price, for public realizes that 16-30-odd tube telly set will cost more than 2-5-tube midget radio.

"We'll save it on the movies" is important public reaction. So movie cos. which are wise are arranging to garner income from sale of films & stars to telly bests.

As editorial points out, there is concerted drive to sabotage telly. It has little chance, because public not only is being subjected to heavy pro-telly publicity campaign, but is convinced by own eyes that telly is good entertainment—worth buying. Telly saboteurs are said to be considering abandoning drive & leaping madly aboard band-wagon. When FCC is converted & telly time sales go commercial, get ready for biggest boom industry has known since 1922.

### OTHER TELLY NEWS

Zenith has announced that its telly sets would be rented, not sold, until telly standards were definitely established.

BBC (British) telly will spend \$2½ million on programs & production in '39.

Theater telly big biz in Britain. Baird will equip another doz. movie houses for large-screen telly. As to Scopphony, see pic, Page 35.

Didja know that the word is around that the National Radio Parts Show will be sponsoring a demonstration of telly receivers in cooperation with RCA? We heard about it unofficially.

William Priess, head of Int. Radio & Television Corp., is reported readying sets to give large images at \$200 & up. Rumor also is that a station will be using his system (a mechanical one)—and R.T.D. even goes so far as to guess that it's an Illinois outfit, now using standard C-R system. Priess' will be 200 lines, interlaced, using vibrating mirror.

Newest outfit making kits is Fulton Radio Corp., N.Y.C. Will sell for \$89.50, less tubes. Console cabinet for 5-inch job will run about \$20.

And newest tube co. is Cath-Ray Electronics Labs., Inc., of Newark, N. J. Robert Robins (of Wald, not DeWald) will head the firm.

First intramural fashion telecast took place at Bloomingdales, N.Y. dept. store, over Amer. Tel. Corp. apparatus. (Said to be same eqpt. used in the Bklyn, N.Y., telly demo. of operations R.T.D., reported last mo.) Store plans to use it as regular promotion feature.

Baird representative arrived in U.S. with theater & home telly jobs, & demonstrated latter successfully to the press.

### FACSY FACTS

The Columbus *Dispatch*, owners of WBNS, Columbus, O., will use RCA facy on a wave that will not interfere with its radio transmissions.

RCA facy is being used by stations in France, Italy, Russia & Germany, as well as several in dear old U.S.A.

### SALES HELPS & DEALS

(Continued from page 36)

*Transformer Corp. of Amer.* is offering \$5 for the best photo & story of a *Clarion* installation each month. Non-winning, acceptable pix will get \$1.50; all others will be returned. Pix must be 5 x 7" or larger, & should include the Serviceman who did the job.

More *National Union* deals: 6-drawer 50-compartment stock cabinet with \$60 (list) worth of N.U. condensers; 38-compartment cabinet with \$30 worth. Chanalyst deal now featured in 2-color, cartoon-style broadside.

Please Say That You Saw It in **RADIO-CRAFT**



# RADIO TRADE DIGEST

## STATE TO PROTECT RADIOS

(Continued from page 35)

all state cops with radio. Wash. would put Servicemen in extra-hazardous class under Compensation Act. Mass. wants a state board similar to FCC. (Similar law in N.J. was declared unconstitutional.) Mont. would tax take from coin-operated phonos, etc.

## TRADE SLANTS

(Continued from page 36)

thing he wishes but must mention the RSA and cannot use the word "free". The station gives RSA a program each Sunday to match the amount of money spent each week. On this program, members tell the people of Green Bay why they should call a member of RSA; and conduct a question and answer interview. Slogan is "Call an RSA Man."

**Duluth Chapter:** An ordinance drawn up by Bemidji, Minnesota, making it unlawful to cause radio interference was discussed by Joe Brief at a meeting. Under this plan, a radio interference inspector was appointed to handle complaints and warrants. Complaints are referred to local radio Servicemen for eliminating interference.

Publicity Committee submitted a share-the-expense advertising scheme over a local broadcasting company.

**Fort Wayne, Indiana, Chapter:** devoted meeting to ways and means of combating unethical advertising and the problem of discounts. Chapter has limited qualified membership to financially responsible Servicemen.

Henry Schryver, President, has developed a new break-down condenser tester for intermit-tents.

Don Stover of Freeport, Illinois, Director of RSA District 10, presented Chapter's Charter on behalf of the Board of Directors, and outlined the democratic set-up of RSA, and the accomplish-ments and plans for RSA. Don also presented a talk on a practical V.-T.V.M., its theory, service uses, and construction.

**Chicago Chapter:** "On the Merry-Go-Round with the High Freaks" could have been the headline describing television lecture given by Jean Brand, E.E., IRE. His story of his own personal experiences with the Ultra-High-Freq.'s came as a timely warning to the alert and am-bitious to get going now.

"Recent Development in Single-Ended Metal Tubes" was the technical topic discussed by Ernest Kohler, Jr., of Ken-Rad Tube Co. The in-formation thus gained prepared members for field troubles of an added kind, in conjunction with the new tun d-inductance circuits.

The Chapter appropriated the necessary money to print "Brandex", the long heralded index-booklet on private brand and off-brand receivers. These booklets will be available exclusively to RSA members everywhere, and should prove a valuable addition to any Serviceman's library. The price is 25c; edition is limited. Write Al Kilian, 414 Dickens Avenue, Chicago, Illinois.

**Cleveland Chapter:** is planning a credit "black list" of customers to be available to members. Has also laid plans for curbing customer's wholesale buying. Distributors will be asked to cooperate.

A special meeting to be held soon is planned as a get-together for old timers in the Radio Servicing Industry.

**Colorado Springs Chapter:** "Cozy" Strang, Chief-engineer of KVOR spoke on "Modern Broadcast Transmitters". He told a great deal that will help in proper servicing, and a later meeting was given over to a discussion of meth-ods of curbing tube discount to garages and serv-ice stations without radio departments. Members also discussed the possibility of improving the electrical interference ordinances in this city.

## AN EDITORIAL

(Continued from page 37)

The tip-off is that, while there is an argu-ment against television, no one is arguing in favor of it. *They don't need to.* A demon-stration is the best argument for television. One demonstration convinces the sceptics.

All except the one man we mentioned a couple of paragraphs ago, of course.

## SNOOPS & SCOOPS

(Continued from page 38)

*If you didn't hear that Crosley intro-duced a 6-cylinder, \$395 car late in April, one of our wires is grounded . . . Five men in Knoxville, Tenn., & 3 in Los Angeles were convicted of television swindles (5 of 'em were from N. Y.) . . . And R-C has done to prove that the latter 3 moved from their "factory," leaving no address, in 1935!*

G-E will have no less than 5 models of telly receivers, and still—oh, read the Edi-torial . . . Radiomarine Corp. of Amer. models ET 8010 & ET 8010A have won FCC approval . . . A selected group of Service-men is receiving instruction on handling & servicing Du Mont telly receivers, at the co.'s plant . . . Wholesale Radio Equipt. Co. & Apex Rotavex Corp. ran a 7-day cruise to Havana for "qualifying" dealers.

The Natl. Assn. of Bestrs. is working to shorten commercial announcements, which will probably result in the sale of more sets—& radiadvertised mdse . . . Farns-worth Tel. & Radio Corp. stock hit the market at \$6 . . . Tobe Deutschmann Corp. has a 2-side 12-in. record for dealers; on 1 side is a recording of man-made static from various sources—on the other, a 5-min. talk on interference elimination by Mr. D.—a 4-star idea.

Consolidated Corps. is out with a new line of fully guaranteed ant., i.f., r.f., osc., & choke coils; they're so precision-made as to be interchangeable—nice goin', C. C. . . .

Continental Elec. Co. has some lovely new vacuum gauges that should interest tube mfrs. & people who give intelligence tests to most news commentators.

Universal Microphone Co. has dynamic, ztal & carbon mikes in all needed im-pedances—& 1 of them has been okayed by the U. S. Civic Aeronautics Authority . . . You knew that KDKA's new transmitter is near Allison Pk., outside Pittsburgh, didn't you? (R.-C.'s R. M. in R. editor says his dept. has run the info.) . . . R. D. W. writes that his pet peevr is midget sets which have their p-b tuners on the front—thinks the buttons should be on top, to prevent skidding the set when you pooshem. He's got something there . . . Speaking of sidelines how do you like Crosley's new car?

Cornell-Dubilier announces a new line of Dykanol capacitors (condensers, to you) specially designed for use in telly receivers & xmtrs . . . Philco is pushing a new phono needle to provide minimum needle scratch & surface noise—& they have a new carry-ing case for test equip't Nos. 033, 077, 044 & 027 . . . Watch your d'ily pipers for dope on the Philco telly sets, early in June; about the same time Stewart-Warner will disclose a plan whereby new models won't obsolesce the old ones on your shelves . . . and by then you will have heard about Stromberg-Carlson's radio & telly line for 1940.

(Continued on following page)

Please Say That You Saw It in RADIO-CRAFT

**GET THIS**  
**WORLDS!**  
**GREATEST**  
**RADIO**  
**CATALOG**  
**FREE!**  
**164 PAGES**  
*of Super Values!*  
*Everything in Radio*  
**AT**  
**LOWEST**  
**PRICES!**

The New 1939 Radolek Radio Profit Guide is the world's finest, most complete Catalog of Radio Parts and Equipment. Completely revised, right up to the minute, bringing you "Everything in Radio" . . . AT **LOWEST PRICES!** Packed with money-saving radio-buying information . . . every page brings you **EXTRA PROFITS.** Contains over 12,000 items . . . the most comprehensive exact duplicate replacement parts listings of Volume Controls, Condensers, Transformers, Vibrators ever compiled. A complete new selection of Radio Receivers and Public Address Equipment, Tubes, Auto Radios and Test Equipment. New profits for you in Electrical Appliances, Clocks, Power Tools, Electric Shavers, etc. Radolek offers you one complete speedy source for all your radio needs . . . a complete stock . . . ready for prompt shipment to you. This Book is your handy index to Radolek's huge storehouse of Radio Super-Values. You need it—it's FREE.

**MAIL THIS COUPON**

The **RADOLEK Co.**

601 W. Randolph, Chicago, Dept. C-31

Send the 1939 Radolek Radio Profit Guide Free.

Name .....

Address .....

Serviceman?  Dealer?  Experimenter?



*Index to advertisers*

<b>A</b>	
Aerovox Corporation .....	51
Aladdin Radio Industries .....	61
Alden Products Company .....	61
Allied Radio Corporation .....	53
Amplifier Company of America .....	42
Amplitone Products Company .....	61
<b>B</b>	
Brush Development Company .....	61
Burstein-Applebee Company .....	61
<b>C</b>	
Capitol Radio Engineering Institute .....	59
Central Radio Laboratories .....	45
Classified Section .....	58
Cornell-Dubilier Elec. Corp. ....	Inside Front Cover
Coyne Electrical School .....	3
<b>D</b>	
The Data Print Company .....	40
<b>F</b>	
Foto-Craft Magazine .....	42
<b>H</b>	
Hammarlund Mfg. Company .....	55
Hygrade Sylvania Corporation .....	40
<b>L</b>	
Lafayette Radio Corporation .....	55
Lancaster, Allwine & Rommel .....	59
Lincoln Engineering School .....	40
<b>M</b>	
Meissner Manufacturing Co. ....	Back Cover
Modell's .....	61
Myetic Mike Company .....	40
<b>N</b>	
National Plans Institute .....	44
National Radio Institute .....	1
National Schools .....	47
National Union Radio Corp. ....	47
<b>O</b>	
D. W. Onan & Sons .....	59
<b>R</b>	
Radio & Technical Publishing Co. ....	57
Radio City Products Company .....	51
Radio Publications .....	56
Radio Servicemen of America, Inc. ....	48
Radio Training Association .....	41
Radolek Company .....	63
RCA Institutes, Inc. ....	45
RCA Manufacturing Co., Inc. ....	Inside Back Cover
Readrite Meter Works .....	45
Recoton Corporation .....	59
Remington Rand, Inc. ....	47
<b>S</b>	
Solar Manufacturing Company .....	43
Solter Radio Company .....	59
Sprague Products Company .....	49
Sprayberry Academy of Radio .....	53
Superior Instruments Company .....	39
Supreme Instruments Corp. ....	41
Supreme Publications .....	59
<b>T</b>	
Technifax .....	52
Triplett Elect. Instrument Co. ....	43
<b>U</b>	
United Radio Company .....	61
<b>W</b>	
Wellworth Trading Company .....	44
Wholesale Radio Service Co., Inc. ....	49
Wright-DeCoster, Inc. ....	57
<b>X</b>	
X-L Engineering Company .....	58

(While every precaution is taken to insure accuracy, we cannot guarantee against the possibility of an occasional change or omission in the preparation of this index.)

**RADIO TRADE DIGEST**

Students are rushing to enroll in *Philco's* service courses on refrigeration & air conditioning, a home study skule . . . The co. has prepared service bulletins on these subjects, too, covering their line . . . *Oxford Tartak Radio Corp.*, speaker mfrs. are enlarging their plant again . . . Among the U. S. products now banned in New Zealand are radios.

And as a reward for reading this far, we'll tell you that you may expect television soon in Phila, Los Angeles, Boston, Baltimore & Cincy—in all of which sites have been leased!

**Bogen Appoints Radolek**

The Radolek Company of Chicago has been appointed distributor in northern Illinois and Indiana for Bogen Sound Equipment. The complete line of amplifiers, recorders, and accessories will be featured.

**PERSONALS**

(Continued from page 38)

**OCTAVE BLAKE**, pres., **LEON L. ADELMAN**, Jobber Div. Sales Mgr., **WILLIAM DUBILIER**, 1st v.-p., **CHARLES H. CAINE**, 2d v.-p. & Chi rep., **WILLIAM M. BAILEY**, chief eng., **PAUL McK. DEELEY**, electrolytic div. chief eng., & **FRANK TAYLOR**, sales eng., will represent **Cornell-Dubilier** at the **Natl. Radio Parts Trade Show** in Chi. June 14-17, introducing several new products.

**JAMES J. LAWLER**, safety engineer of **Hygrade Sylvania's** Emporium plant, was elected to the **Amer. Society of Safety Engineers** in recognition of his outstanding work. The co. had only 3 industrial accidents resulting in a loss of 64½ days working time. Total hours worked by all employees was 1,918,427.

**RALPH T. BRENGLE**, taken ill last autumn, has retired from **Clough-Brengle**. **WILLIAM MEYENBERG**, former production mgr. at **All-American, Carter, & Silver-Marshall**, succeeds him as plant mgr.; **ARTHUR R. HALL**, secy., succeeds him as treas.

**NILES TRAMMELL**, exec. v.-p. of **RCA**, has been elected to the board of directors of that co.

**LEONARD W. JOY**, with **RCA-VICTOR** since '26, has been put in charge of all the co.'s recording activities in N.Y. His new title is **Manager of Artists & Repertoire**.

**PERRY F. HADLOCK**, for 11 years with **G-E**, succeeds **E. H. Vogel**, resigned, as manager of the co.'s radio sales division.

**LEONARD F. CRAMER** has become gen. sales mgr. of **Allen B. Du Mont Labs.**, with **G. ROBERT METZGER** as his assistant.

**LATEST PUBLICATIONS**

(Continued from page 38)

**HAMMARLUND "39" CATALOG**—2nd edition. **Hammarlund Mfg. Co., Inc.**, 424 W. 33rd St., N.Y.C. 20 pp. Descriptions, pix & prices on condensers, coil forms, chokes, I.F. transformers, kits & sets.

**CLARION SPRING SOUND SYSTEMS CATALOG**. **Clarion Inst. of Sound Engineers**, 69 Wooster St., N.Y.C. Descriptions & new low prices on 22 systems, 17 mikes, 12 P.A. speakers, 16 baffles, etc.

**EVERYTHING IN RADIO**. **Allied Radio Corp.**, 833 W. Jackson Blvd., Chicago, Ill. 164 pp. Individual sections on receivers, P.A. equip't., service equip't., ham gear, kits, parts, accessories, etc. More than 14,000 items are listed. One of the most comprehensive catalogs this reviewer has seen—with some swell buys!

**FOX SOUND EQUIP'T. CORP.**, 3120 Monroe St., Toledo, O. **Permanent-Magnet Speaker**, 4 pp.; **Electro-Dynamic Unit** (3 types), 4 pp.; **Sound Projectors**, 2 pp.; **Utility Line baffles & stands**, 2 pp.

**CARTER MOTOR CO.**, 1608 Milwaukee Ave., Chicago, Ill. New circulars on **genemotors & converters**; also heavy-duty units for police radio work.

**RECEIVING TUBE LIST**. **Ken-Rad Tube & Lamp Corp.**, Owensboro, Ky. 9 pp. Includes data on characteristics indicating interchangeability.

**"T"-LINE TRANSFORMERS**. **Kenyon Transformer Co., Inc.**, 840 Barry St., N.Y.C. 16 pp. Features circuit diagrams & data for ham apparatus, new items & revised prices.

**REPLACEMENT TRANSFORMER ENCYCLOPEDIA**, NO. 243-D. **Thordarson Elec. Mfg. Co.**, 500 W. Huron St., Chicago, Ill. 8 pp. Data on replacements for all 1938-'9 sets listed in Vol. IX of **Rider's Manual**; supplements No. 243.

**VIBRAPACK**—Form E-555-B. **P. R. Mallory & Co., Inc.**, Indianapolis, Ind. 8 pp. Describes standard line, including 3 new models: 2 heavy-duty dual units, & a special 32-volt job for farm use.

**PRICE SHEETS NOS. 51-T & 51-I**. **Triplett Elec. Inst. Co.**, Bluffton, O. Each 4 pp. 51-T lists standard models & new P-B operated **Vibrator Tester**; 51-I shows several changed prices, & includes new line of **Dynamometer-type wattmeters**, appliance tester, etc.

**VIBRATOR REPLACEMENT CHART**. **James Vibrapower Co.**, 3125 N. Oconto Ave., Chicago, Ill. 6 pp. Also includes wiring diagrams & specifications of mfr.'s units.

**ESSENTIALS OF RECORDING**. **Allied Radio Corp.**, 833 W. Jackson Blvd., Chicago, Ill. 22 pp. Data on problems of recording in non-technical language, with some data & prices on equip't. Charge of 10c for booklet.

**TRANSCRIPTION RECORD PLAYER**. **Terminal Radio Corp.**, 68 W. 45th St., N. Y. C. 2 pp. Data & pix on new portable record player.

**\*PERIODICALS RECEIVED:**—**P. R. S. M. A. NEWS** for April, with service hints on **RCA** sets.

**SYLVANIA NEWS**, for April, includes data on new tubes: 7B5, 7B6, 7C5.

**RADIO SERVICEMAN**, for April, with news of Chapter activities.

**OHMITE NEWS**, for April, has data on how to arrange a test circuit for resistance application.

**RADIOGRAM**, for May, institutional data.

**\*NOTE:** Addresses of these publications will be sent on request to those enclosing self-addressed stamped envelope.

**RECORD RENEWER NOW OFFERED IN SMALL SIZE**

In addition to the 2-oz. 50c size illustrated below, **RECOTON Corp.**, N. Y. City, now offers its well known **Liquid Record Renewer** in a small 15c bottle, packed 12 in an attractive full-color display box. This preparation is favored by professionals and home record-lovers, because it cleanses, protects and preserves the original hi-fidelity quality of today's fine discs. **R.T.D.** points out that coin-phonograph operators may find this a useful item.





# RCA Radiotrons Have the Advantage of RCA's TELEVISION Experience

Let the radio owners in your neighborhood know you use and recommend RCA Radiotrons—the tubes built by the company that brought television to America...the tubes that are backed by the same careful research and built with the same skill that made the television dream an actual fact. The public will be impressed with this story—will come to you for RCA Radiotrons!

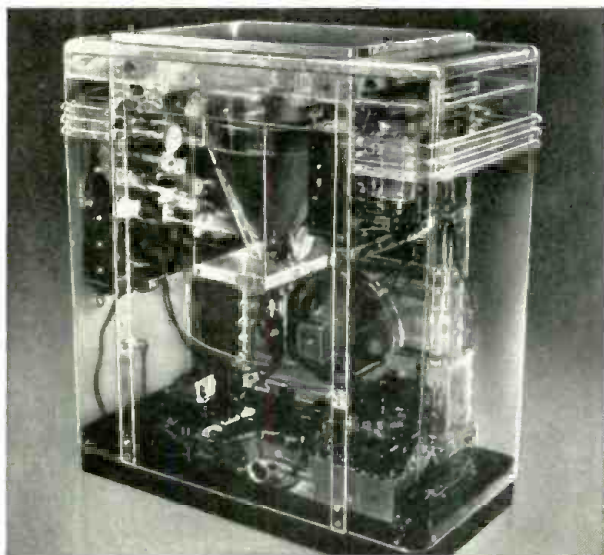

Above is shown a glass-enclosed interior of RCA Victor Television receiver on display at New York World's Fair. You can capitalize on the tremendous publicity that is being given RCA Victor Television if you feature RCA Radiotrons.

Over 335 million RCA radio tubes have been purchased by radio users ...in tubes, as in parts and test equipment, it pays to go RCA All the Way ... Trademarks "RCA Victor" and "RCA Radiotrons" Reg. U. S. Pat. Off. by RCA Mfg. Co., Inc.

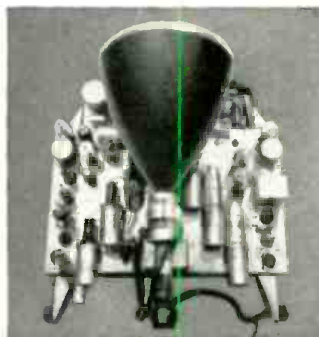

Typical RCA Victor Television chassis shows large number of tubes used. This is going to help you boost your RCA Radiotron business because eventually all of these tubes will have to be replaced.

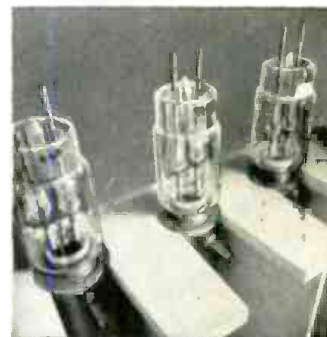

These are RCA High Frequency Television Tubes, built by the same men who build RCA Radiotrons. The same research and skill that are responsible for these tubes are also incorporated in RCA Radiotrons.

**RCA invites you to visit its display at the National Radio Parts Trade Show, Stevens Hotel, Chicago, June 14-17**



# Radiotrons

RCA Manufacturing Co., Inc., Camden, N. J. • A Service of the Radio Corporation of America



# Get the Low-down on TELEVISION

WITH A

*Meissner*

**TELEVISION KIT  
COMPLETE . . . SAFE  
. . . GUARANTEED . . .**

**\$139<sup>50</sup> INCLUDING  
ALL TUBES**



Using the new 5" RCA Cathode Ray Tube No. 1802-P4 with Push-Pull Electrostatic Deflection prevents keystoneing (distortion at edges) and permits perfect focusing. Kit complete in every detail.

**SEND FOR FOLDER**

Meissner has developed this Kit — your OPEN SESAME to the thrilling World of Television — expressly for the Nation's HAMS and experimentors.

The Meissner Television Set has been engineered to the most exacting specifications. It gives you a Video and Audio Receiver, that is highly sensitive, flexible and efficient. You'll not only get superb results but cash in on your technical knowledge and skill by turning out a Set that will be the envy of all who see it — and, of course, at a

great saving over the commercially assembled sets the layman buys.

Get the whole story. Mail coupon for Folder shown above. It tells all about this brilliantly engineered, up-to-the-minute Set...explains its many unique features in detail...including the SPECIAL SAFETY Devices which automatically protect you from all danger of shock from the High Voltage Current.

WRITE FOR OUR NEW 1939-40 CATALOG — OFF THE PRESS JUNE 15TH

**YOUR OPPORTUNITY**

The early radio experimentors are to-day's leaders in the industry. Television now offers you a similar opportunity to get in on the ground floor. Get started by building the Meissner Television Receiver.

MAIL IN ENVELOPE OR PASTE ON PENNY POSTCARD

MEISSNER MANUFACTURING COMPANY  
Mt. Carmel, Illinois, Dept. RC-7

- Send me the Television Kit Folder
- Send me Meissner's complete new 1939-40 Catalog

Name.....  
Address.....  
City..... State.....